



**GLASS DESIGN
COLLECTION**

Eyecatcher für Ihr Bad



GLASS DESIGN

GLASS DESIGN, ein italienisches Unternehmen, ein Spezialhersteller für Waschbecken und Accessoires, befindet sich im Herzen der Toskana, in Vinci gelegen, der Heimatstadt von „Leonardo da Vinci“.

Glass Design wurde 1984 von der Familie Borsellini gegründet und blickt auf eine lange Tradition hinsichtlich der Glasherstellung und Manufaktur zurück. Das Unternehmen fertigt handbearbeitete Unikate, die in aller Welt geschätzt und in über 60 Ländern dieser Erde exportiert werden.

Aber auch andere Materialien wie handgetöpferte Keramik, Marmor, Mineralwerkstoffe oder Silikon werden verarbeitet und tragen so zur Schaffung eines neuen Stils bei, in dem auch die Accessoires eine wichtige Rolle spielen.

Über 200 toskanische Glashandwerker und 15 Glasbläser aus Murano arbeiten innerhalb der Glass Design Produktionskette. Das Unternehmen ermöglicht mit seinen einzigartigen und exklusiven Produkten eine individuelle Anpassung an die verschiedenen Bedürfnisse unserer Zeit.

FORM FOLLOWS EMOTION.

MAGAZIN UND
MATERIALÜBERSICHT
8 – 23

Florence Glass
ATELIER
68 – 107

Marmo
CALACATTA
120 – 129

Vetro Freddo[®]
144 – 181

Cristallo
DE' MEDICI[®]
Pb 24%

32 – 67

Terra di
SIENA
130 – 143

made with
MURANO[®]
glass
108 – 119

Pert[®]
polimero tecnologico
182 – 191

Siliconio®

192 – 197

UNIKO

METALLMÖBEL

212 – 227

Glamorous

TUNING

234 – 269

ACCESSOIRES

274 – 287

STANDWASCHTISCHE

198 – 211

ARIUS

H O M E

270 – 273

BADEWANNEN

228 – 233

SORTIMENTSÜBERSICHT

290 – 415

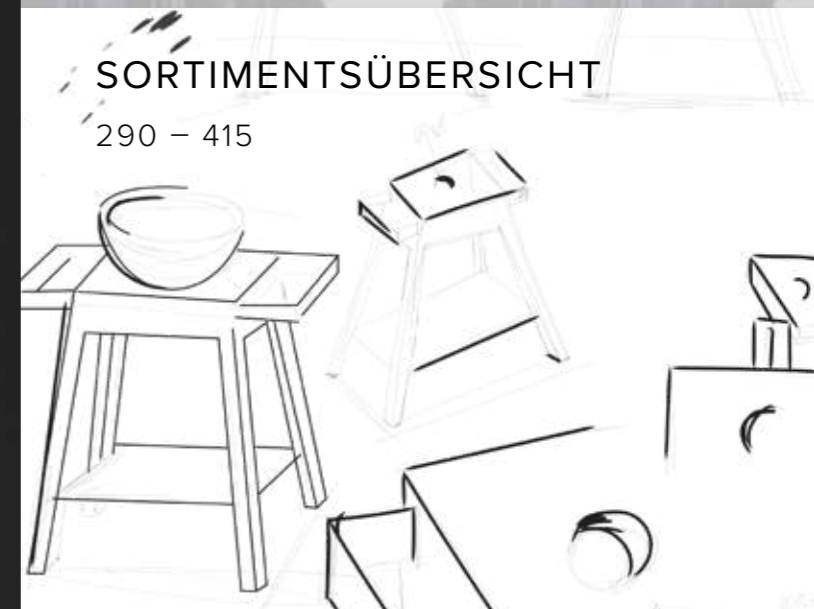



WILLKOMMEN IN DER WELT VON GLASSDESIGN

Eyecatcher bringen Leben in Ihr Bad, ziehen alle Blicke auf sich und zeigen Mut für das Besondere.

Die Hingucker aus den unterschiedlichen Kollektionen denken gar nicht daran, sich zu verstecken oder sich einem übergeordneten Designkonzept unterzuordnen. Sie sollen auffallen und dem Bad eine besondere, eine persönliche Note geben.

Extravagante Eyecatcher wie die Waschtische von Glass-Design stimulieren unsere Sinne und bringen ein unbeschwertes Flair ins Bad. Schlichte Badmöbel, zurückhaltende Wandgestaltung und eine puristische Architektur bieten den Waschtischen die perfekte Bühne für den großen Auftritt.

Die große Material- und Farbauswahl ermöglicht einen nahezu unbegrenzten Gestaltungsspielraum in der Inszenierung des Waschplatzes. Ob die handgefertigten Waschtische aus mundgeblasenem Kristallglas, die natürlichen Modelle aus handgetöpfter Keramik oder die in nahezu unbegrenzter Farbauswahl lieferbaren Modelle aus VetroFreddo im Produktportfolio von GlassDesign findet jeder Designliebhaber ein passendes Modell.

In diesem Katalog erleben Sie eine breite Auswahl an unterschiedlichsten Designs, Materialien, Oberflächen und Farben. Lassen Sie sich begeistern und kreieren Sie Ihren ganz persönlichen Wohlfühlort.

Die Glaskünstler blasen zwischen 15 und 30 kg flüssiges, rund 1.000 °C heißes Glas in eine Eisenform.



Diese äußerst raffinierten Produkte werden von unseren Meisterkünstlern nach den ältesten und edelsten Glaskünsten mundgeblasen.



Viele Modelle werden neben transparentem Glas auch in schwarzem Bleikristallglas hergestellt. Entdecken Sie die neuen Oberflächen Rubinrot, Smaragdgrün, Cobaltblau und Gewittergrau.



Inspired by the world of fashion,
the Florence Glass Atelier
collections always take current
trends and colors into account.



Waschtische aus VetroFreddo® sind Unikate mit hohem Design, fein verarbeitet, mit perfekt geformten Winkeln und einer glatten Oberfläche, mit der Möglichkeit, aus einer breiten Palette von Farben zu wählen, um den individuellen Anforderungen gerecht zu werden.



Die Glaspartikel werden in das mineralische Rohmaterial gemischt und erhitzt, die flüssige Masse wird dann von Hand in die Beckenform gegossen. Nachdem das Material abgekühlt ist, werden alle Kanten und Radien von Hand nachbearbeitet. Die Farben und Oberflächen werden auch hier wieder von Hand aufgetragen.

Per Hand wird das Material von unseren Meisterhandwerkern gemischt. Dabei wird auf höchste Präzision geachtet.





Die Erde ist die Inspirationsquelle für die handgetöpferten Waschtische der „Terra die Siena“ Kollektion. Leichte Farbunterschiede und Formabweichungen zeugen von der handwerklichen Qualität des Herstellungsprozesses.





MATERIALIEN FÜR DIE SINNE

Mit Moodboards visualisieren wir Ideen die noch nicht existieren. Egal ob Sie Ihr Bad im natürlichen Stil, ehr mediterran oder besonderes luxuriös gestalten die perfekte Harmonie von Materialien, Farben und Oberflächen ist entscheidend für Ihr neues Badezimmer.

Die kleinsten Details machen den feinen Unterschied aus. Jedes GlassDesign Produkt ist ein handgemachtes Unikat und verleiht Ihrem Bad eine persönliche Note.





UNSERE DESIGNER

Das Glass Design Team arbeitet mit weltberühmten Designern und Architekten zusammen, die seit Jahren Produktentwicklungen und Unternehmensprojekte unter der Leitung unseres Kreativdirektors und Geschäftsführers Gian-Luca Borsellini durchführen.

KARIM RASHID



MARCO PISATI



VINCENZO MISSANELLI



LUCA BOJOLA



GIAN LUCA BORSELLINI



GIACOMO MASONI



LUCA GNIZIO



LEONARDO GIOMARELLI



ALESSANDRO LENARDA





Die Cristallo de Medici® Waschtische werden mundgeblasen und von Hand geschliffen. Die Glasbläser blasen zwischen 15 und 30 kg flüssiges, rund 1.000°C heißes Glas in eine Eisenform. In dieser Eisenform sind immer zwei Becken, da immer eine geschlossene Form geblasen werden muss. Diese Arbeit ist anstrengend und erfordert eine langjährige Erfahrung. Leichte Luftschlüsse lassen sich bei diesen Becken nicht vermeiden, sind bei den geschliffenen Modellen aber nicht zu sehen.

Das Glas ist 24%iges Bleikristallglas. Das Besondere an diesem Glas ist seine Brillanz und die Transparenz.



Die eleganten Marmorsorten Calacatta und Marquina werden zu einzigartigen Aufsatzbecken verarbeitet. Die Maserung des Natursteins ist individuell und wird nur durch die Natur beeinflusst. Marmor ist ein unvergleichlicher Luxus.



Hier ist wirklich jedes Stück ein einzigartiges Meisterwerk. Die Murano Becken werden nach 500-Jahre alter Tradition auf der kleinen Insel Murano bei Venedig hergestellt. Die Farbtiefe und die Formen machen diese Becken zu etwas ganz Besonderem. Murano Aufsatzbecken sind Unikate, die immer etwas anders aussehen. Kleine Luftschlüsse sind nicht zu vermeiden und gehören zu einem handgemachten Murano-Glas-Becken ganz selbstverständlich dazu.



Alle Waschtische der Florence-Glass-Atelier® Kollektion werden aus Kristallglas hergestellt. Das Kristallglas wird thermisch verformt und so in die Beckenform gezogen. Von außen werden die unterschiedlichsten Dekorationen und Techniken auf das Glas aufgetragen. Vom Beton über flüssiges Metall bis hin zu echtem Gold. Diese Becken sind inspiriert von aktuellen Modeströmungen. Da alle Becken innen aus Kristallglas bestehen und die Dekoration immer außen aufgetragen wird, sind diese Becken leicht zu reinigen.



VetroFreddo® ist eine Materialkomposition aus Kunstharz und Glas (Ital. kaltes Glas). Das Rohmaterial wird erhitzt und von Hand in die Beckenform gegossen. Nachdem das Material abgekühlt ist, werden alle Kanten und Radien von Hand nachbearbeitet. Die Rohmaterialien sind immer weiß matt oder schwarz matt. Alle anderen Farben und Oberflächen werden auch hier wieder von Hand aufgetragen. So wird z. B. das Blattgold Blatt für Blatt in drei Lagen auf das Becken aufgelegt. Die VetroFreddo® Becken können mit der Anti-Scratch Oberfläche zusätzlich geschützt werden.



Pert® Aufsatzbecken aus einem Polymermaterial sind besonders hart und extrem leicht. Durch diese Materialeigenschaften können sehr filigrane Formen umgesetzt werden. Das Rohmaterial wird immer mit einer Oberfläche veredelt. Von schlichten Farben angefangen bei Weiß, über handbemalte Oberflächen wie Alt-Bronze und Alt-Kupfer, bis zum Blattgold ist nahezu alles möglich.



Die Terra di Siena® Kollektion umfasst handgetöpferte Waschbecken. Hier wird jedes Waschbecken klassisch auf einer Töpferscheibe von Hand gefertigt. Jedes Becken ist ein Unikat und kann in Größe und Oberfläche leicht variieren. Das Imperfekte macht hier den Reiz aus. Die Innenseiten der Becken werden mit einer Keramikglasur glasiert.



Siliconio® ist „Touch Design“ von seiner besten Seite. Unzählige kleinster Silikonkügelchen werden in einer Beckenform zu einem Waschbecken verschmolzen. Das Material ist extrem robust und weich.





CRISTALLO DE' MEDICI 32

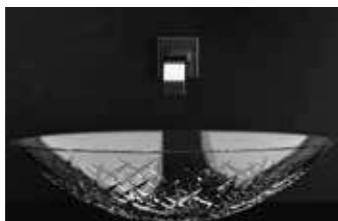

ICE OVAL 34



ICE ROUND 35



ICE LUX 36-37



ASTRO 59



SCENIC ASTRO 60-61



AQUA 62



PREMIUM 63



SCENIC ICE 38-39

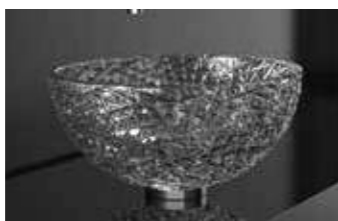

ICE 34 40



ICE SMALL 41



VILLA / VILLA LUX 42-43



MOON 64-65



ROYAL ABSOLUTE 66

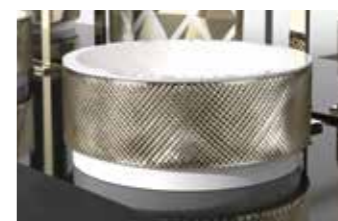

ROYAL ABSOLUTE 40 67



FLORENCE GLASS ATELIER 68



GIOTTO 44



VOLÉ GIOTTO 45



VOLÉ SOLE 46

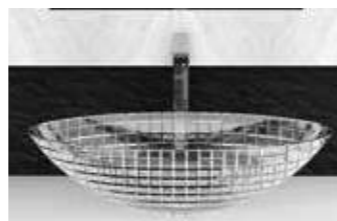

LUXOR OVAL 47



METROPOLE KATINO 70-71



METROPOLE OVAL 72



METROPOLE 73



LUNA 74



LUXOR ROUND 48-49



COLLIER 50



RAMADA 51



RAMADA LUX 52-53



LUNA KATINO 75



GRAFFITI 76-77



GRAFFITI 2.0 78-79



LUSSO 80



SCENIC RAMADA 54-55



CLIVIA 56



CHELO 57



VOLTA 58



LUSSO KATINO 81



KLIO 82-85



BAMBOO KATINO 86-87



OCEAN 88-91

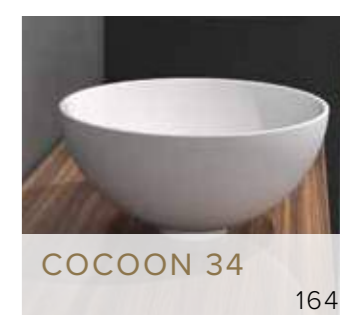
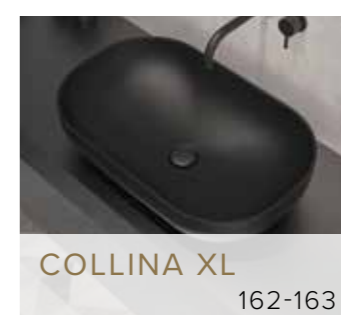
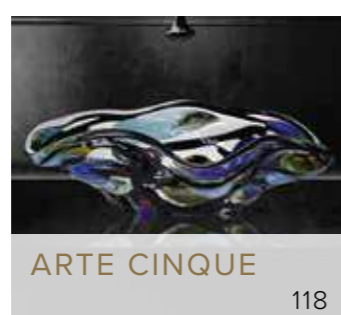
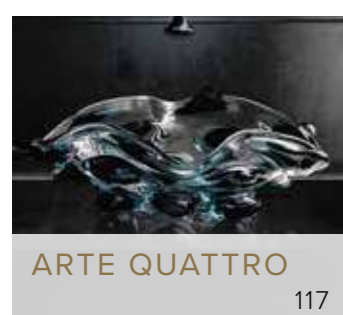
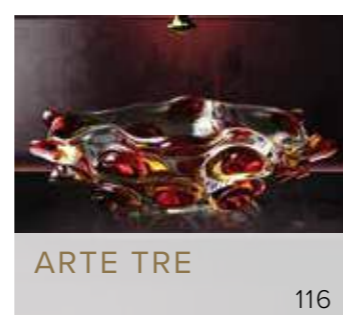
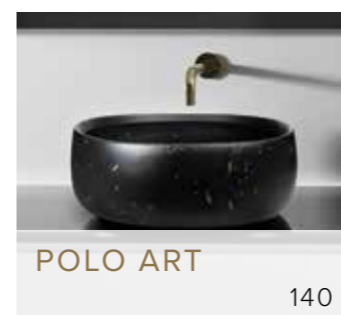
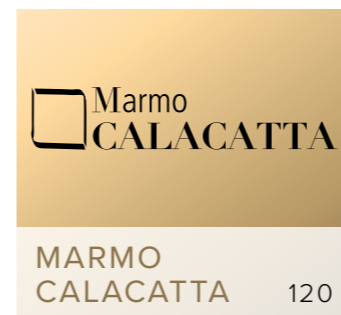
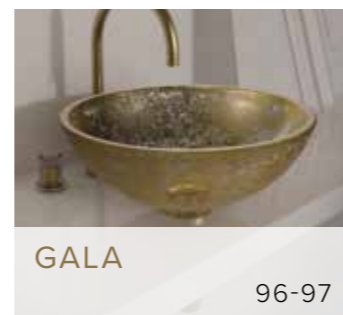
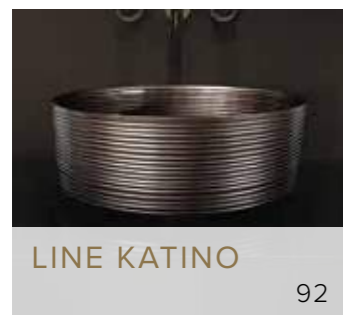

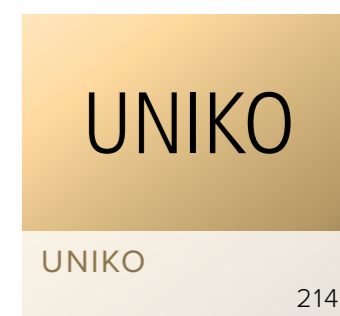
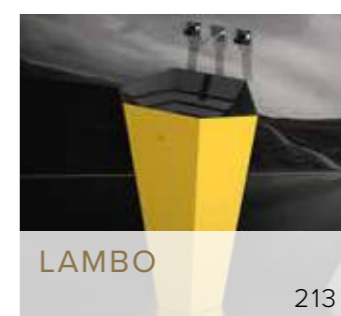
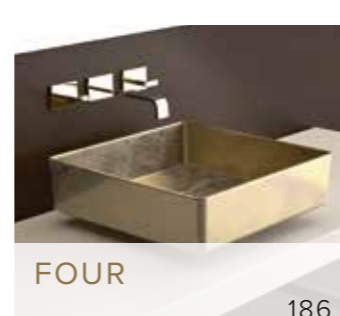
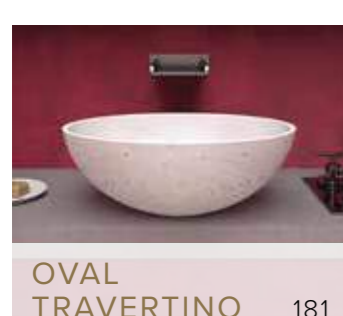
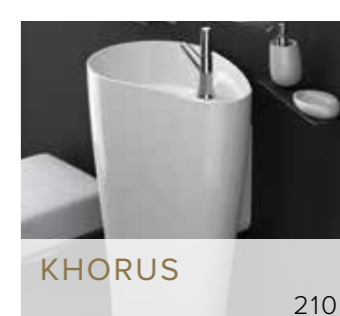
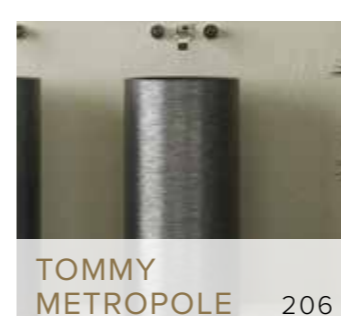
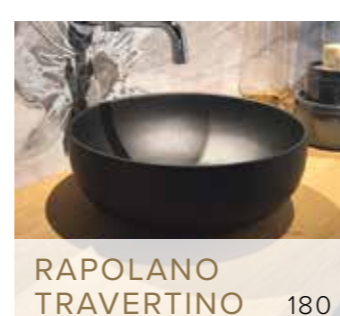
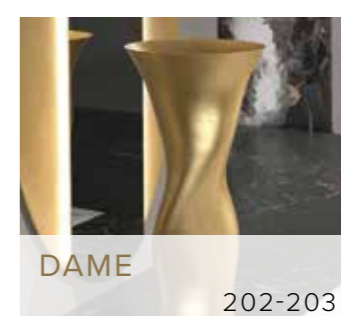
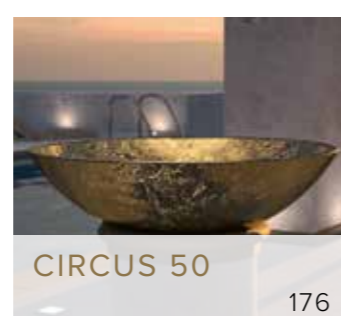
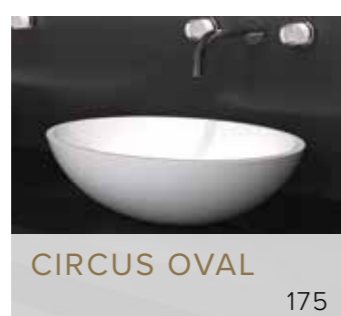
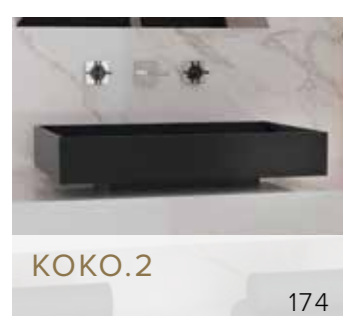
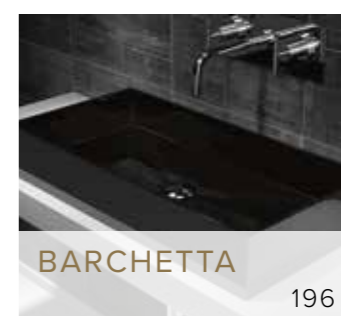
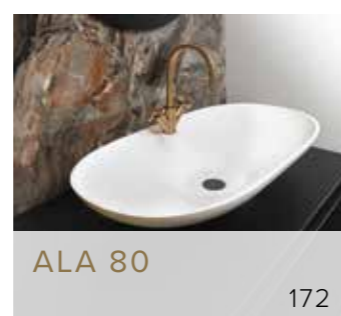
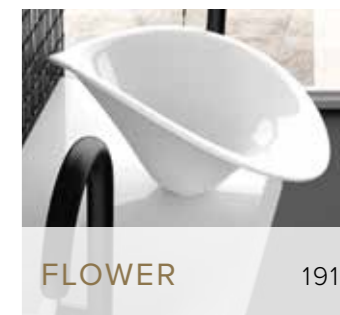
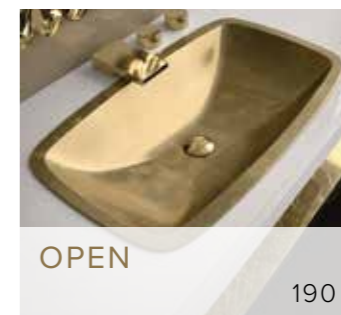
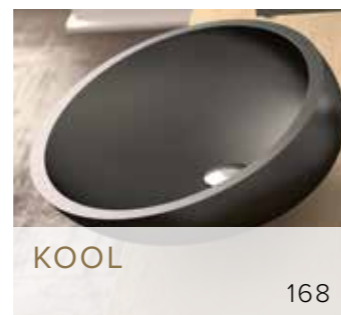



TONDO COMPACT
216-217



TONDO PLUS
218-219



ONE PLUS
220-221



BLOOM PLUS
222-223



VALENTINO
280



ARIA
281



METROPOLE
282



LINEA
283



MOVE PLUS
224-225



ELLE PLUS
226-227



ITALY PLUS
228-229



BADEWANNEN
230



GRAFFITI 2
284



LUNA
285



LUXURY
286



MODE LUX
287



FLOWER STYLE 2
232-233



MINI STYLE 2
234-235



GLAMOROUS
TUNING
236



GLAMOROUS
240-247



NAVY
288



KOOL
288



CARRARA
289



SORTIMENTS-
ÜBERSICHT
290



TOWER
248-257



REGENTS
258-261



LYRIC
262-271



ARIUS[®]
H O M E
272



REGISTER A-Z
414



TÜRGRIFFE/
MÖBELGRIFFE
274



ACCESSOIRES
276

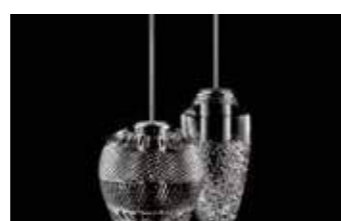

OPERA /
CANTO
278



ROYAL
279



 **Cristallo**
DE' MEDICI[®]
Pb 24%



INSPIRIERT VON DEN ÄLTESTEN UND EDELSTEN GLASKÜNSTEN

Exklusive Waschtisch-Kollektionen aus purem 24% Bleikristall: Diese äußerst raffinierten Produkte sind mundgeblasen und werden von unseren Meisterkünstlern nach den ältesten und edelsten Glaskünsten geschliffen.

Die Glasbläser blasen zwischen 15 und 30 kg flüssiges, rund 1.000°C heißes Glas in eine Eisenform. Diese äußerst präzise und anstrengende Arbeit erfordert eine langjährige Erfahrung. Leichte Lufteinschlüsse lassen sich bei diesen Becken nicht vermeiden, sind bei den geschliffenen Modellen aber nicht zu sehen. Das Glas ist 24%-iges Bleikristallglas. Das Besondere an diesem Glas sind seine Brillanz und die Transparenz. Viele Modelle werden neben transparentem Glas auch in schwarzem Bleikristallglas hergestellt. Entdecken Sie die neuen Oberflächen Rubinrot, Smaragdgrün, Cobaltblau und Gewittergrau.

Bei der „Lux“ Version dieser Becken wird das transparente Kristallglas von außen galvanisiert. Dieses ist in Gold, Silber, Bronze und Platin möglich und bringt absoluten Luxus in ihr Bad.

DIE CRISTALLO ART EDITION.



ICE ROUND, Transparent

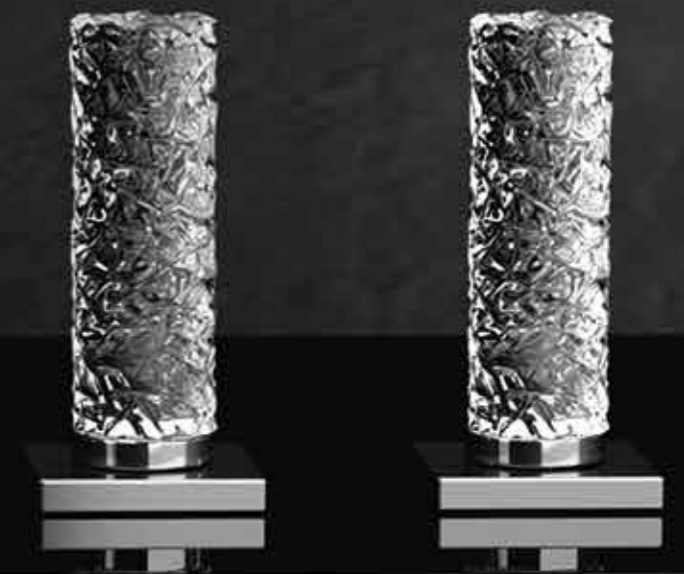

ICE OVAL, Transparent
GLAMOROUS ICE XL, Transparent

43 x 28 cm

51 x 34,5 cm

56 x 38 cm

43,5 cm

34 cm



ICE LUX, Bronze



ICE LUX, Platin



ICE LUX, Gold



ICE LUX, Silber



ICE LUX, Gold
LYRIC ICE, Transparent / Gold

- 34 cm
- 43,5 x 29 cm
- 51 x 34,5 cm
- 56 x 38 cm



SCENIC ICE, Transparent
LYRIC ICE, Transparent/Silber

44 cm

ICE 34

ICE SMALL



ICE 34, Transparent
LYRIC ICE, Transparent/Silber

34 cm



ICE SMALL, Transparent

43,5 x 29 cm



VILLA, Transparent

ICE LUX, Bronze



ICE LUX, Platin



ICE LUX, Gold



ICE LUX, Silber





GIOTTO, Transparent

33 cm

43 cm

VOLÉ GIOTTO, Transparent

VOLÉ SOLE

Cristallo
DE' MEDICI
Pb 24%

LUXOR OVAL

GD
GLASS DESIGN
ITALY



VOLÉ SOLE, Transparent

43 cm



LUXOR OVAL, Transparent

51 x 34,5 cm

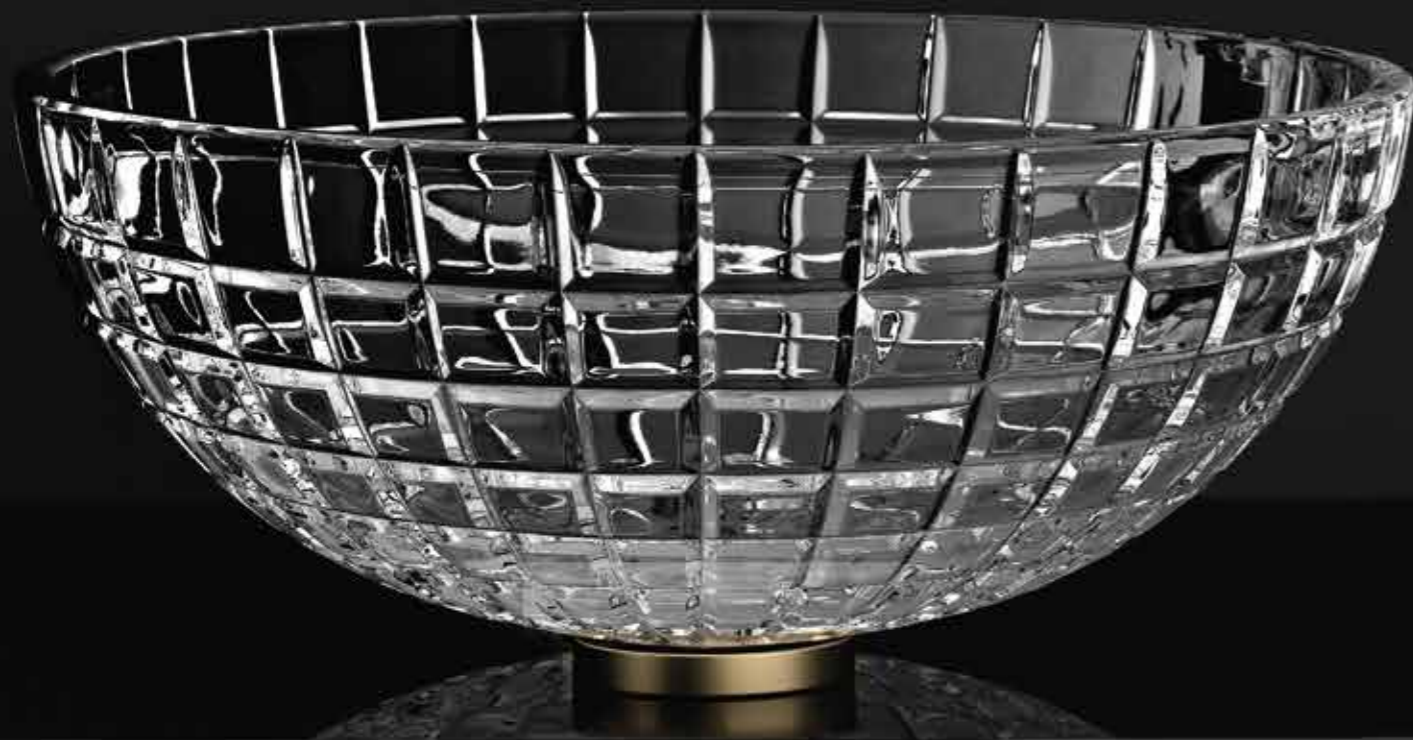

LUXOR ROUND, Transparent
GLAMOROUS LUXOR XL, Transparent/Messing matt

43,5 cm

COLLIER



COLLIER, Schwarz

51 x 34,5 cm

RAMADA



RAMADA, Transparent
LYRIC RAMADA, Transparent-Silber / Chrom

34 cm



RAMADA LUX, Bronze



RAMADA LUX, Platin



RAMADA LUX, Gold



RAMADA LUX, Silber



RAMADA LUX, Gold
LYRIC RAMADA, Transparent-Gold / Gold

34 cm



SCENIC RAMADA, Transparent



SCENIC RAMADA, Smaragdgrün



SCENIC RAMADA, Cobaltblau



SCENIC RAMADA, Rubinrot



SCENIC RAMADA, Gewittergrau

44 cm



CLIVIA, Transparent

40 cm



CHELO, Transparent
LYRIC, Transparent/Weiß

34 cm

VOLTA



VOLTA, Transparent / Gold
LYRIC CLIVIA, Transparent / Gold

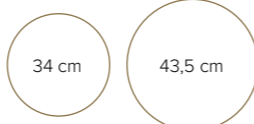

ASTRO



ASTRO, Transparent / Gold





SCENIC ASTRO, Transparent / Chrom
TOWER CLIVIA, Transparent

44 cm

SCENIC ASTRO, Transparent / Chrom
TOWER CLIVIA, Transparent

AQUA

PREMIUM



AQUA, Transparent



AQUA, Schwarz

40 cm



53 x 35 cm



PREMIUM, Gewittergrau



PREMIUM, Transparent
LYRIC PREMIUM, Transparent / Silber



MOON, Transparent

34,5 cm



ROYAL ABSOLUTE, Schwarz matt/Bronze

36,5 cm



ROYAL ABSOLUTE 40, Weiß glänzend/Light Gold

40 cm



Florence Glass
ATELIER®



BATHROOM GOES FASHION

Die Waschtische der Florence Glass Atelier® Kollektion sind inspiriert von den neuesten Trends im Fashion- und Interior-Bereich.

Das hochwertige, transparente Kristallglas wird in Handarbeit mit verschiedensten Dekorationen veredelt. Die unterschiedlichsten Dekorationen und Techniken werden auf der Außenseite des Beckens in aufwendiger Handarbeit auf das Glas aufgetragen. Vom flüssigen Metall, das aufgebürstet wird, über Beton, der in mehreren Schichten aufgetragen wird, bis hin zu echtem Gold ist jede Dekoration und jedes Becken ein besonderes Meisterwerk.

Da alle Becken innen aus Kristallglas bestehen und die Dekoration immer außen aufgetragen wird, sind diese Becken leicht zu reinigen.

EXKLUSIVE WASCHTISCH-KOLLEKTION
INSPIRIERT DURCH DIE WELT DER MODE.

METROPOLE KATINO



METROPOLE KATINO, Bronze



METROPOLE KATINO, Platin



METROPOLE KATINO, Gold



METROPOLE KATINO, Anthrazit



METROPOLE KATINO, Silber



METROPOLE KATINO, Weiß



METROPOLE KATINO, Blau



METROPOLE KATINO, Aquamarin



METROPOLE KATINO, Pink



METROPOLE KATINO, Anthrazit

39,9 cm

METROPOLE OVAL



METROPOLE OVAL, Anthrazit

METROPOLE



METROPOLE, Blau



METROPOLE OVAL, Platin



METROPOLE, Aquamarin

51 x 39 cm

44 cm

40 cm

34 cm

30 cm

LUNA

LUNA KATINO



LUNA, Sand

LUNA, Weiß

LUNA, Betongrau

- 34 cm
- 40 cm
- 44 cm
- 45 cm
- 51 x 39 cm



LUNA KATINO, Betongrau

LUNA KATINO, Sand

- 39,9 cm



GRAFFITI, Schwarz/Gold/Elfenbein



GRAFFITI, Rot/Gold/Elfenbein



GRAFFITI 2.0, Schwarz/Silber



GRAFFITI 2.0, Weiß/Gold



LUSO KATINO, Gold Blattauflage 3D



LUSO, Gold Blattauflage 3D

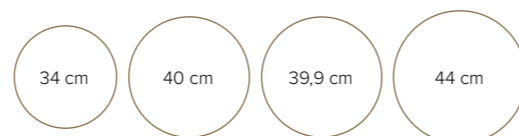

LUSO, Gold Blattauflage 3D

LUSO, Silber Blattauflage 3D



KLIO, Bronze matt

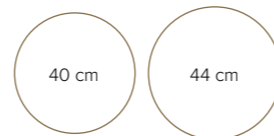

KLIO, Gold matt



KLIO, Bronze



KLIO, Gold



KLIO, Silber



KLIO, Silber matt

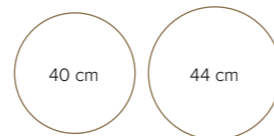

BAMBOO KATINO



BAMBOO KATINO, Weiß

39,9 cm



BAMBOO KATINO, Grau



OCEAN, Schwarz / Gold

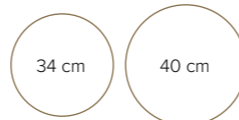

OCEAN, Blau / Gold



OCEAN, Schwarz/Silber

34 cm 40 cm



OCEAN, Weiß/Gold

LINE KATINO

VENICE



LINE KATINO, Anthrazit matt

LINE KATINO, Platin matt



LINE KATINO, Bronze matt

39,9 cm



VENICE, Braun/Elfenbein

VENICE, Silber/Schwarz



VENICE 34, Gold/Silber

44 cm

40 cm

34 cm



XENI, Champagner

44 cm



XENI, Schwarz



XENI, Weiß



GALA, Transparent/Gold

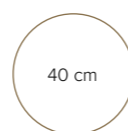

GALA, Kupfer



GALA, Gold



GALA, Silber



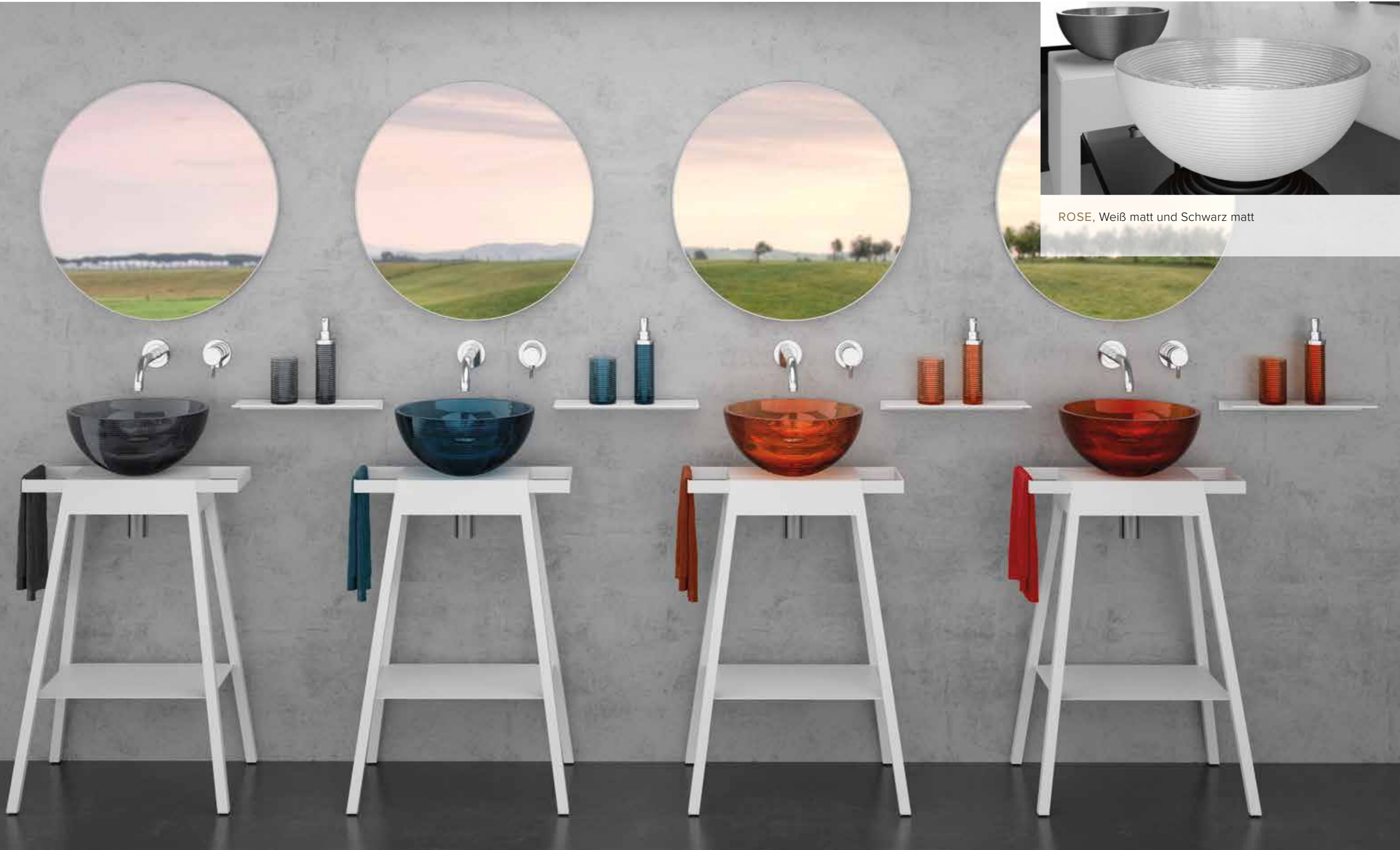

ROSE, Weiß matt und Schwarz matt

ROSE, Gewittergrau/Petrol/Orange/Rubinrot
BLOOM PLUS, Weiß

34 cm



SOFFIO, Transparent

45 cm



SATINATO 44, Satiniert

44 cm



SKYLINE, Schwarz und Weiß

40 x 26 cm

40 x 35 cm

49,6 x 34,6 cm

64,5 x 34,6 cm



SKYLINE, Schwarz

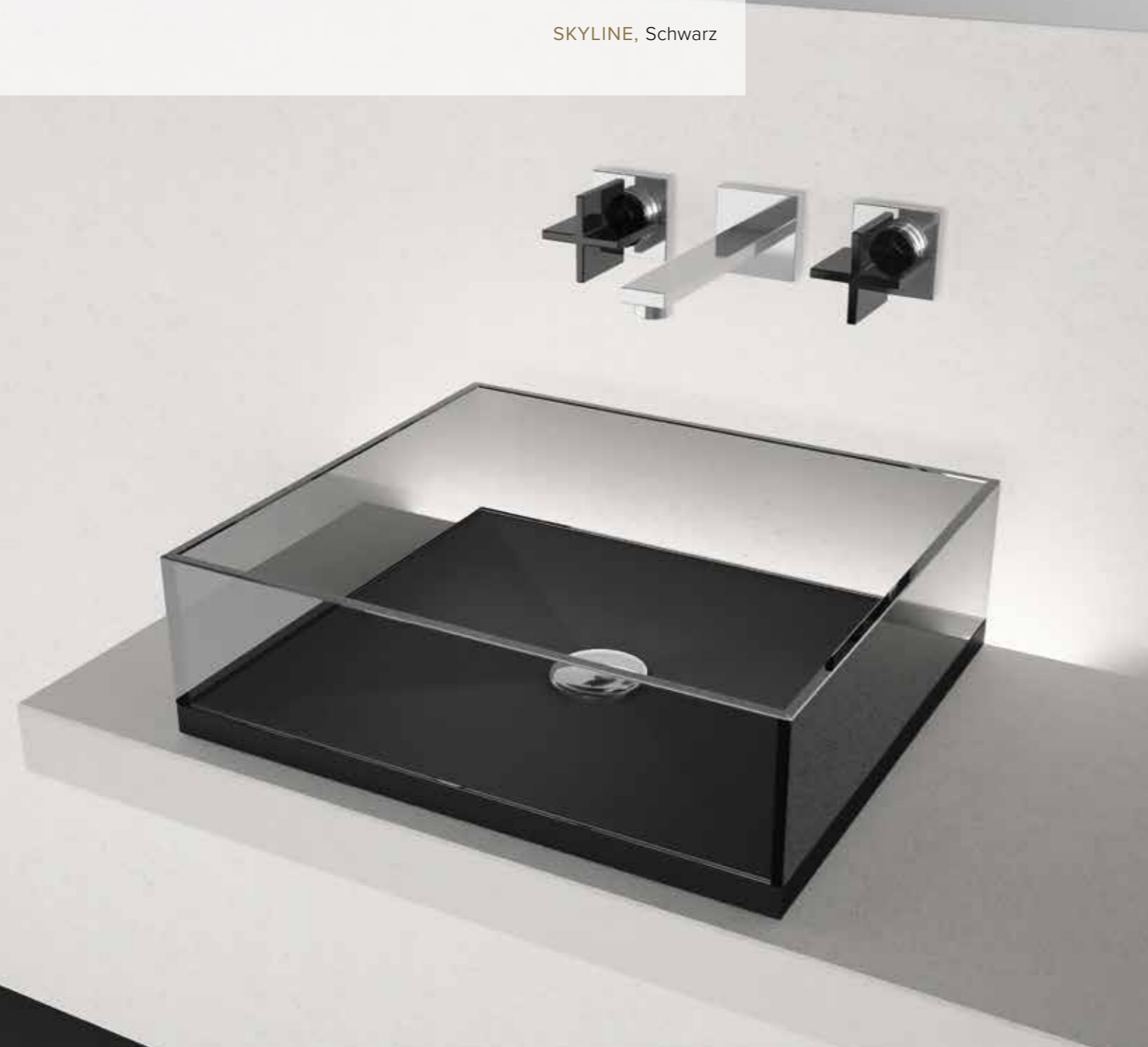

SKYLINE, Fumé/Schwarz



SKYLINE, Weiß

SKYLINE, Transparent/Weiß

XTREME SMALL



XTREME SMALL, Transparent/Schwarz

36,7 cm

XTREME MEDIUM



XTREME MEDIUM, Schwarz

XTREME MEDIUM, Transparent/Schwarz

36,7 cm



made with
MURANO[®]
glass



DAS PRIVILEG DES INDIVIDUALISMUS

Murano Glass[®] ist ein Synonym für Eleganz und Zeitlosigkeit. Durch die Kombination von innovativen Techniken mit traditioneller Handwerkskunst entstehen repräsentative und unnachahmliche Objekte mit einzigartigen Farbkompositionen.

Jedes Stück ist ein einzigartiges Meisterwerk. Die Murano Glass[®]-Becken werden nach 500-Jahre alter Tradition auf der kleinen Insel Murano bei Venedig hergestellt. Die Farbtiefe und die Formen machen diese Becken zu etwas ganz Besonderem.

Diese Aufsatzbecken sind Unikate, die immer etwas anders aussehen. Kleine Lufteinschlüsse sind nicht zu vermeiden und gehören zu einem handgemachten Murano Glass[®]-Becken ganz selbstverständlich dazu.

MEISTERWERKE HANDWERKLICHER TRADITION.

GLO BALL MURANO

made with
MURANO[®]
glass

GD
GLASS DESIGN
ITALY



GLO BALL MURANO, Amber

GLO BALL MURANO, Opal Weiß



GLO BALL MURANO, Cognac, Fumé, Amber

GLO BALL MURANO, Cognac

GLO BALL MURANO, Fumé



GLO BALL MURANO, Opal Weiß

42 cm



LAGUNA, Blau



LAGUNA DEEP, Smoke



LAGUNA, Fumé



ARTE UNO, Transparent mit 24 Karat Goldstaub

65 x 42 cm

65 x 42 cm

ARTE DUE, Schwarz mit 24 Karat Goldstaub



ARTE TRE, Transparent/Rot-Amber

65 x 42 cm

65 x 42 cm

ARTE QUATTRO, Transparent/Blau-Schwarz



ARTE CINQUE, Transparent/Multicolor



65 x 42 cm



OTTICO UNO, handgeformtes Waschbecken, Grau



OTTICO DUE, handgeformtes Waschbecken, Weiß/Gold



37 cm



Marmo
CALACATTA

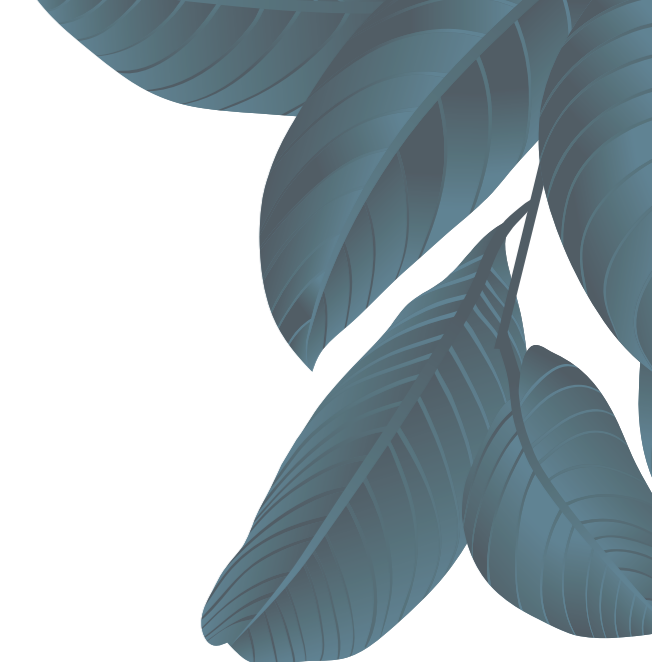

DIE METAMORPHOSE DES MATERIALS

Der ästhetische Wert wird durch die Einzigartigkeit jedes einzelnen Stücks weiter gesteigert. Diese ergibt sich aus den Besonderheiten des Marmors, wie seine Farbe und seine unterschiedliche Marmorierung.

Dank umfangreicher Forschung und Entwicklung in Bezug auf die Verwendung traditioneller Werkstoffe und Materialien konnte das Sortiment um zwei Marmorvarianten erweitert werden.

Calacatta stammt aus den berühmten Steinbrüchen von Carrara und ist eine der wertvollsten und begehrtesten Marmor-Sorten der Welt. Auch Michelangelo verwendete diesen Marmor, um seinen berühmten David herzustellen. Weißer Calacatta lässt dem Design freien Lauf und gewährleistet luxuriöse Ästhetik kombiniert mit lang anhaltender Qualität.

Der schwarze Marquina Marmor kommt aus Steinbrüchen im Norden Spaniens und wird in der Toskana weiterverarbeitet. Die Maserung in diesem Stein hebt seine Einzigartigkeit hervor und macht jeden Waschtisch zu einem Unikat.

KUNST TRIFFT NATUR.



KOOL MAX MARBLE, Calacatta
LYRIC MARBLE, Calacatta/Messing matt

54 x 40 cm



KOOL MAX MARBLE, Marquina
LYRIC MARBLE, Marquina/Dark Platinum matt

54 x 40 cm



KOOL MAX MARBLE, Marquina
LYRIC MARBLE, Marquina/Dark Platinum matt

SKYLINE MARBLE

Marmo
CALACATTA

GD
GLASS DESIGN
ITALY



SKYLINE MARBLE, Marquina/Fumé



SKYLINE MARBLE, Marquina/Fumé



SKYLINE MARBLE, Calacatta/Transparent

SKYLINE MARBLE, Marquina/Fumé
TOWER SMALL, Marquina

49,6 x 34,6 cm

64,5 x 34,6 cm



XTREME MARBLE, Marquina/Transparent
LYRIC MARBLE, Marquina

36,7 cm

XTREME MARBLE, Calacatta/Transparent
LYRIC MARBLE, Calacatta



ZEITLOSE TRADITION

Die Erde selbst ist die Quelle der Inspiration für die Farben und taktilen Empfindungen der zweifarbigen Oberflächen und strukturierten Außenbereiche.

Mit der „Terra di Siena“-Kollektion wird das Glass Design-Sortiment um handgefertigte Keramikwaschbecken ergänzt. Durch die besondere Verarbeitung auf Basis jahrhundertealter Töpfertradition entstehen handwerkliche Unikate mit ganz besonderer Ausstrahlung. Jedes Becken wird klassisch auf der Töpferscheibe von Hand gefertigt. Die bewusste Imperfektion gibt jedem Becken einen einzigartigen Charakter.

CHARAKTERSTÜCKE FÜR IHR BAD.



MODE LUX, Graphit Grau/Dark Inox

42 cm



MODE LUX, Graphit Grau / Bronze



MODE LUX, Graphit Grau/Silber

42 cm



MODE LUX, Graphit Grau/Light Gold



MODE LUX, Weiß matt/Silber

42,5 cm



MODE LUX, Weiß matt/Light Gold

MODE CLASSIC



MODE CLASSIC, Rustic-Weiß



MODE CLASSIC, Vulcano

42 cm

POLO LUX



POLO LUX, Anthrazit Metallic



POLO LUX, Kupfer Metallic

42,5 cm

POLO ART



POLO ART, Schwarz / Gold

42,5 cm

POLO METAL



POLO METAL, Alu Messing



POLO METAL, Corten Stahl

42,5 cm

COLLE



VALLE



COLLE, Anthrazit (innen matt / außen glänzend)

42,5 cm



VALLE, Gold matt

42,5 cm



VetroFreddo®



FORM UND DESIGN OHNE GRENZEN

Der Werkstoff VetroFreddo® ist eine Materialkomposition aus Kunstharz und Glas. „VetroFreddo“ bedeutet übersetzt „kaltes Glas“. Die Glaspartikel werden in das mineralische Rohmaterial gemischt und erhitzt, die flüssige Masse wird dann von Hand in die Beckenform gegossen. Nachdem das Material abgekühlt ist, werden alle Kanten und Radien von Hand nachbearbeitet. Die Farben und Oberflächen werden auch hier wieder von Hand aufgetragen. So wird z.B. das Blattgold Blatt für Blatt in drei Lagen auf das Becken aufgelegt und anschließend mit einer transparenten Glasur geschützt. Die neuen metallischen Oberflächen wie Alt-Innox, Alt-Messing werden sogar auf die Becken aufgemalt, somit ist jedes Becken ein Unikat.

AntiScratch – die innovative Schutzglasur wurde für den Einsatz in Hotels entwickelt. Alle VetroFreddo® Waschtische sind mit der AntiScratch Oberfläche veredelt. (Ausnahme ist Weiß matt) Durch diese zusätzliche Glasur wird das Becken für den täglichen Einsatz optimal geschützt.

**EINZIGARTIGES MATERIAL.
AUSSERGEWÖHNLICHE FARBEN.
INNOVATIVE FORMEN.**



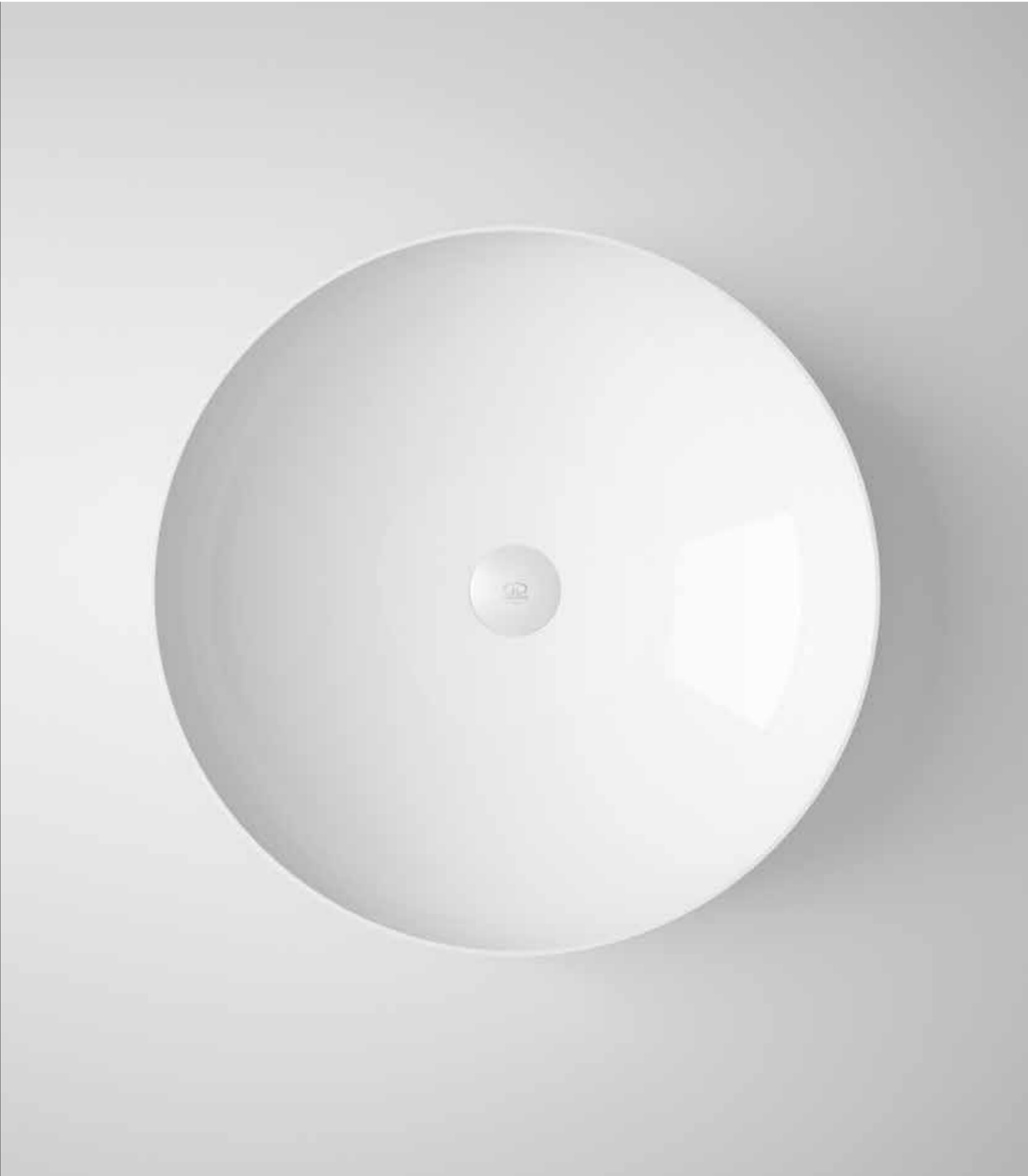

SLIDE 50, Schwarz matt



SLIDE 50, Weiß glänzend

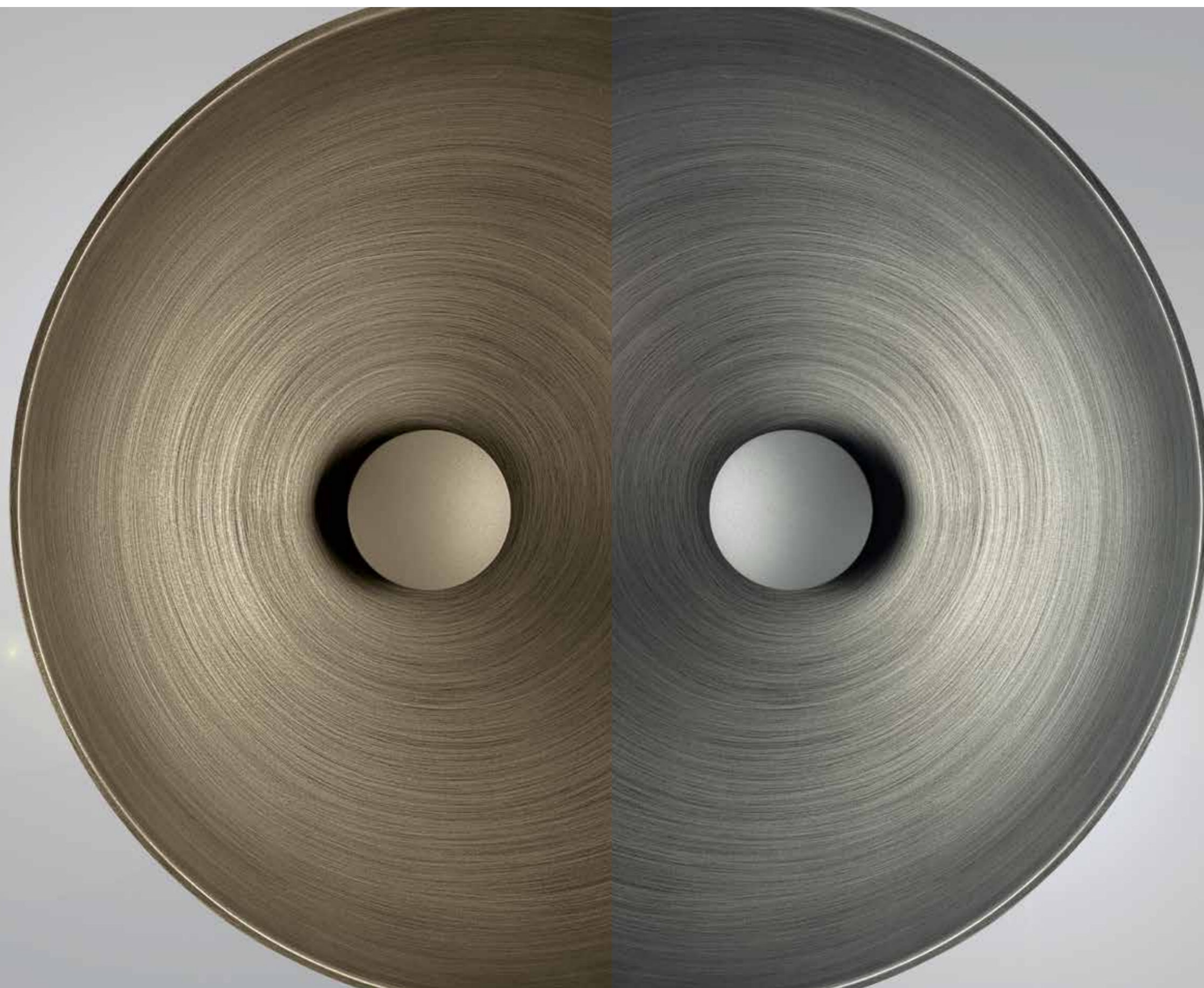

SLIDE 40, Alt Messing

- 34 cm
- 40 cm
- 44 cm
- 50 cm
- 60 x 40 cm
- 60 x 40 cm

SLIDE 40, Dark Inox

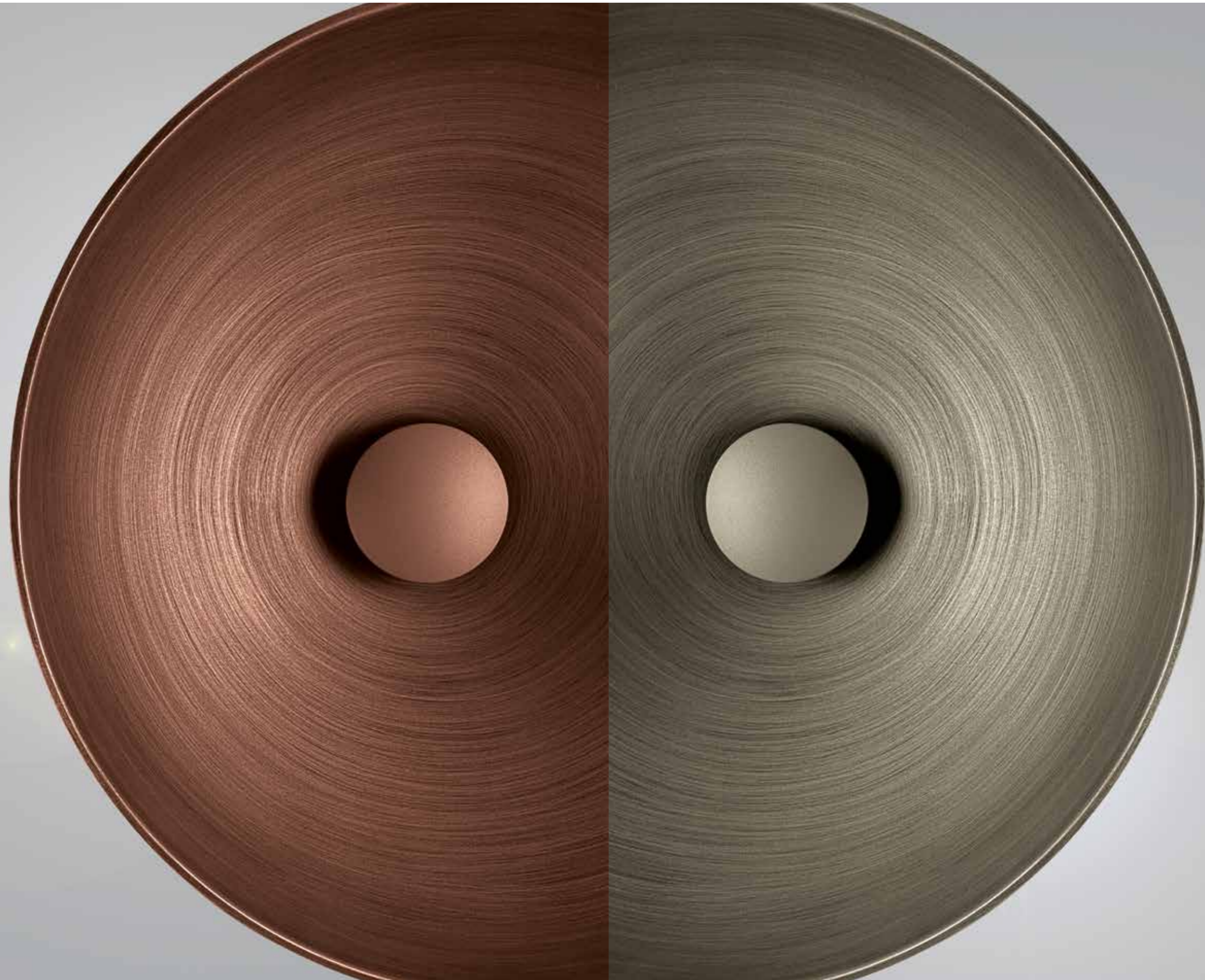

SLIDE 40, Alt Kupfer



SLIDE 40, Alt Bronze



SLIDE OVAL, Grau matt

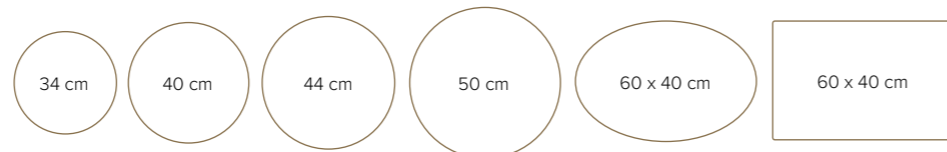

SLIDE 50, Avio matt



SLIDE 44, Weiß matt



SLIDE RECTANGULAR, Schwarz matt

INFINITY OVER

VetroFreddo®

COLLINA



INFINITY OVER, Weiß matt



INFINITY OVER, Weiß matt/Gold matt

52 x 42,5 cm



COLLINA, Schwarz matt

45 cm

35 cm



COLLINA METROPOLE, Schwarz matt/Anthrazit

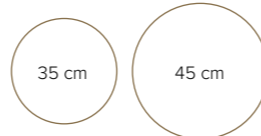

COLLINA 35 METROPOLE, Schwarz matt/Bronze



COLLINA XL, Schwarz matt

63 x 40 cm



COLLINA XL METROPOLE, Schwarz matt/Anthrazit

63 x 40 cm



COCOON 34, Weiß matt

34 cm



COCOON, Weiß matt / Gold matt

49,2 cm



KOOL MAX, Alt-Messing

54 x 40 cm



KOOL MAX, Blattauflege Gold



KOOL, Schwarz matt

43,5 x 36,5 cm



KOOL OVERSIZE, Weiß matt

65 x 48,5 cm





KOOL XL FL, Halbeinbaubecken, Blattauflage Gold

63,5 x 39 cm



KOOL XL, Schwarz matt

64,5 x 39 cm



ALA 80, Weiß matt

80,5 x 45 cm



KONKA, Weiß matt

45 cm

KOKO.2

VetroFreddo®

CIRCUS OVAL



KOKO.2, Schwarz matt



CIRCUS OVAL, Weiß matt

KOKO.2, Schwarz matt

61 x 40 cm

57 x 37,5 cm

CIRCUS OVAL, Weiß matt

CIRCUS 50

VetroFreddo®

CIRCUS 43



CIRCUS 50, Blattaufilage Gold

47,5 cm



CIRCUS 43, Schwarz matt



CIRCUS 43, Blattaufilage Silber



CIRCUS 43, Blattaufilage Gold

42 cm



CIRCUS 43 FL, Halbeinbaubecken, Weiß matt



CIRCUS 50 FL, Halbeinbaubecken, Blattauflege Silber

41,5 cm 47 cm



CIRCUS 43 TRAVERTINO, Weiß

42 cm



RAPOLANO 35 TRAVERTINO, Schwarz matt

35 cm

45 cm



OVAL TRAVERTINO, Schwarz

40 x 30 cm

OVAL TRAVERTINO, Weiß



Pert[®]
polimero tecnologico



SPEKTAKULÄRES DESIGN – LEICHTE, INNOVATIVE FORMEN

Pert[®] ist ein technologisches Polymer von außergewöhnlicher Qualität. Es kombiniert ein niedriges, spezifisches Gewicht mit hoher, mechanischer Beständigkeit. Es ist ein Material, das die Herstellung von außergewöhnlichen Design-Produkten ermöglicht. Winkel und Radien, aber auch glatte Flächen, können perfekt modelliert werden um einzigartige Designideen zu verwirklichen.

Wählen Sie aus einer breiten Palette von Farben, Formen und Oberflächen, um Ihren individuellen Ansprüchen gerecht zu werden.

AntiScratch – die innovative Schutzglasur wurde für den Einsatz in Hotels entwickelt. Alle Pert[®] Waschtische sind mit der AntiScratch Oberfläche veredelt. Durch diese zusätzliche Glasur wird das Becken für den täglichen Einsatz optimal geschützt.

DIE AVANTGARDE-KOLLEKTION



RHO, Schwarz matt
RHO COVER, Schwarz matt

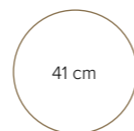

RHO, Alt Bronze / Alt Kupfer



RHO, Alt Messing / Dark Inox

FOUR

Pert®
polimero tecnologico

BLADE

GD
GLASS DESIGN
ITALY

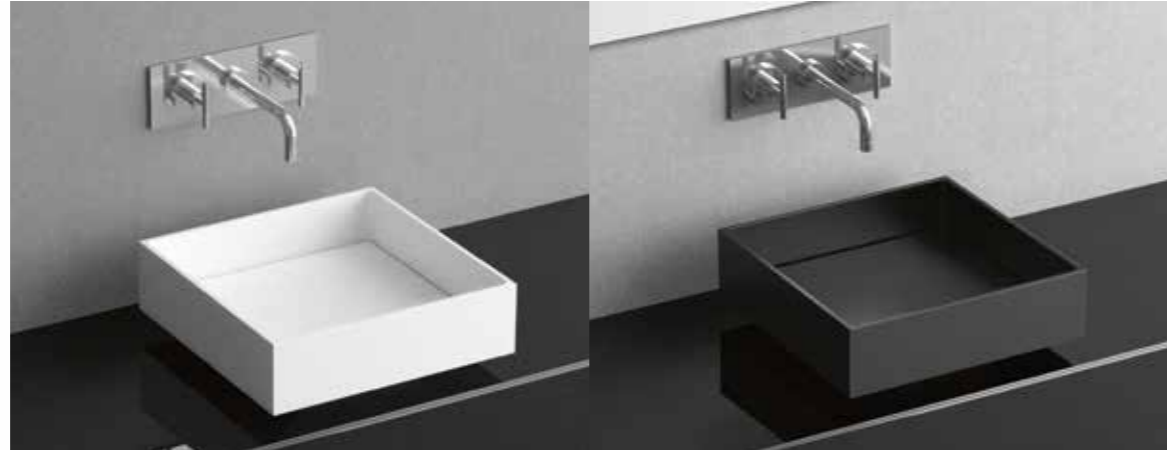

FOUR, Weiß matt
FOUR COVER, Weiß matt

FOUR, Schwarz matt
FOUR COVER, Schwarz matt

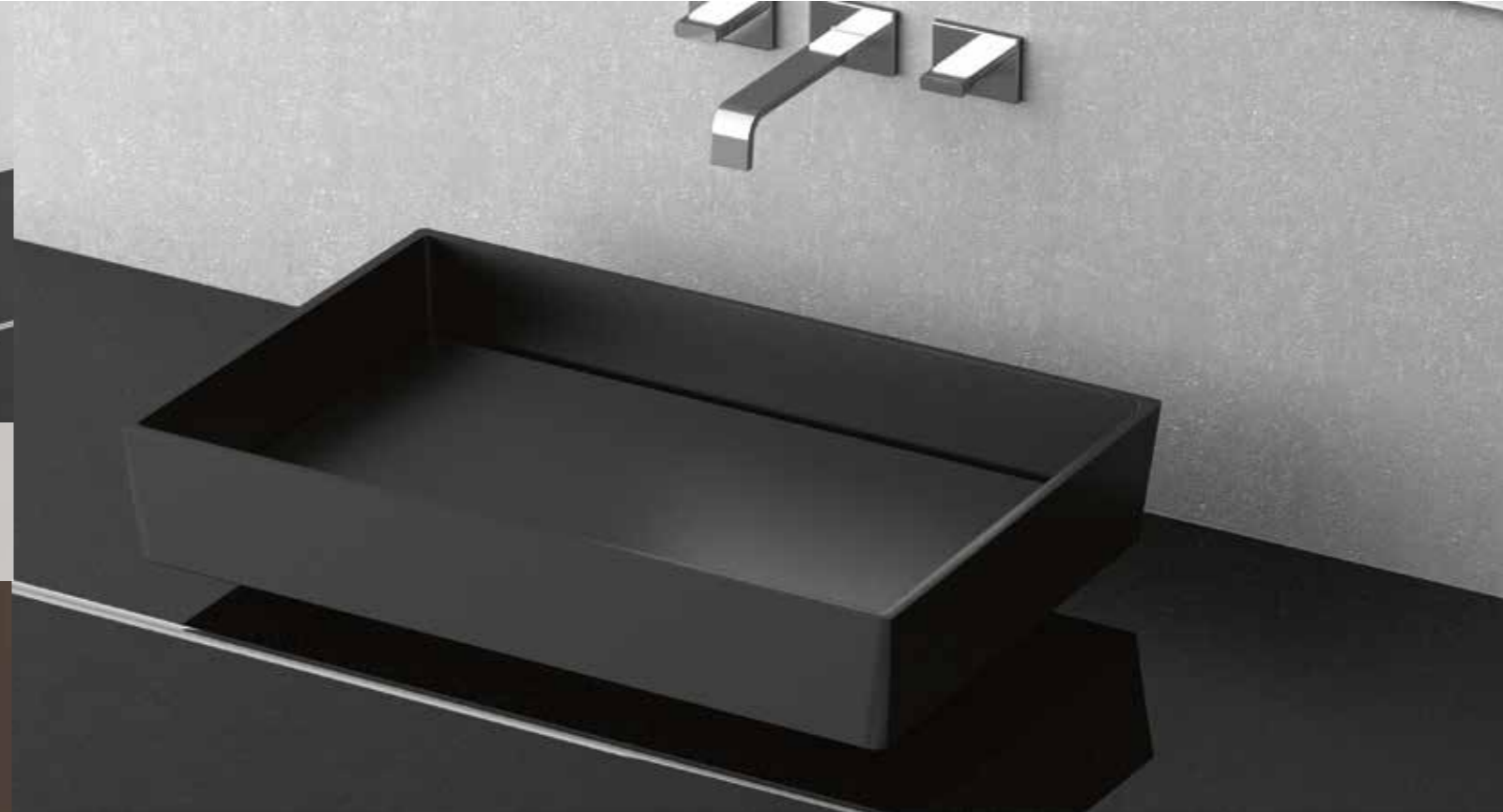

BLADE, Schwarz matt | BLADE COVER, Schwarz matt



FOUR, Blattaufgabe Gold

40 x 40 cm



BLADE, Weiß matt | BLADE COVER, Weiß matt

61 x 40 cm



INFINITY, Ferrari Rot

INFINITY, Weiß glänzend

65 x 38 cm

INFINITY, Weiß matt

OPEN

Pert[®]
polimero tecnologico

FLOWER



OPEN, Blattaufgabe Gold

64 x 37 cm

46 cm

FLOWER, Weiß glänzend

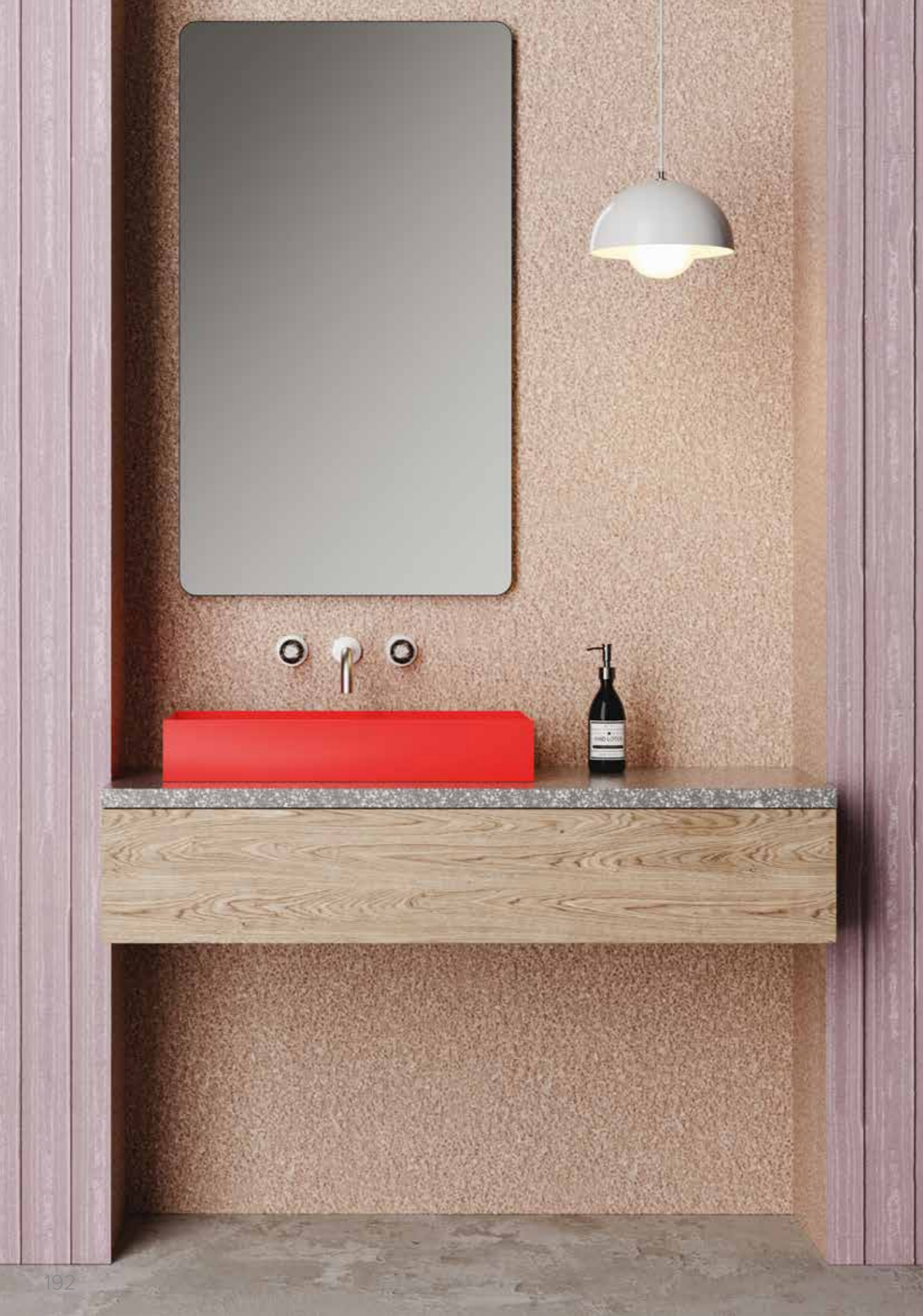

Siliconio[®]

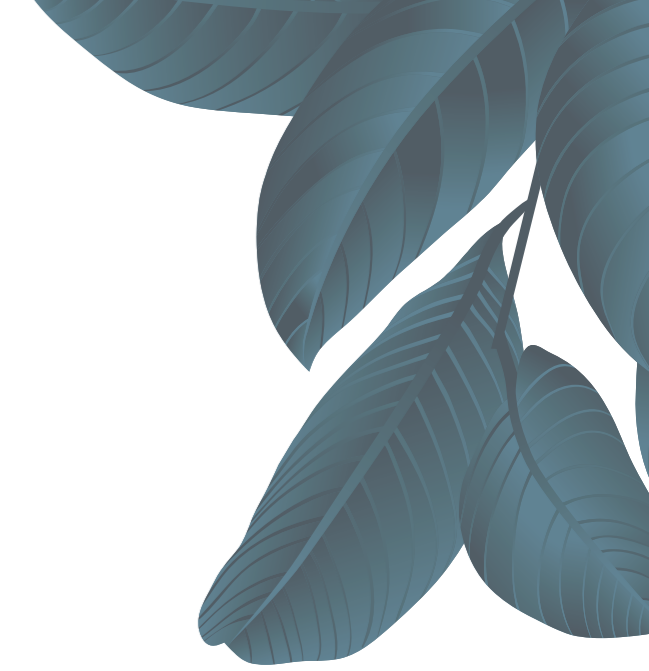

HAPTISCHE EXZELLENZ

Siliconio[®] ist „Touch Design“ von seiner besten Seite. Mit besonderen Designs – die Elastizität des Materials betonend – ermöglicht es Formen und Farben, die von dem großen Potenzial des Materials profitieren.

Es ist ein Material der Berührung: weich, elastisch, sinnlich – einfach einzigartig. Schaffen Sie außergewöhnliche Effekte mit der Kombination aus Licht und Farbe.

Das Material ist extrem robust und weich. Es ist einfach zu reinigen und z. B. für Gäste-WCs, öffentliche Bereiche und Kinderbäder gut geeignet.

ALLE SINNE INVOLVIEREN.



BUBBLE, Rosa

50 x 36 cm

BUBBLE, Gelb



BUBBLE, Hellblau

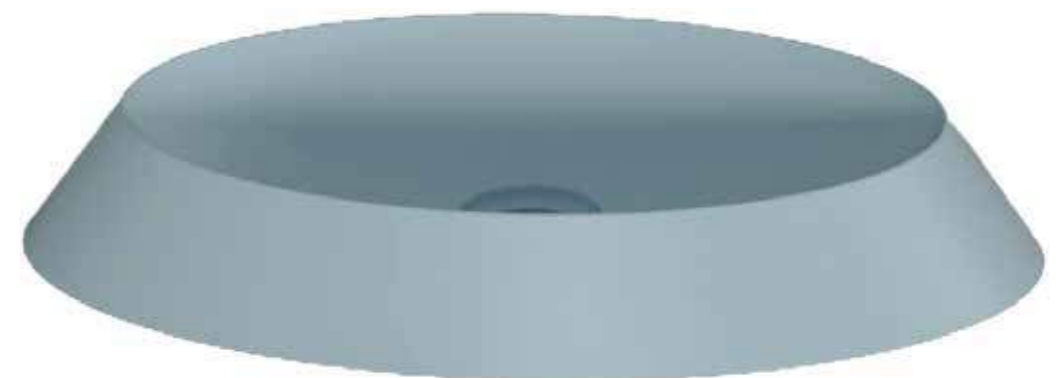

BUBBLE, Violett



BARCHETTA

Siliconio®

GUM



BARCHETTA, Schwarz



BARCHETTA, Rot



BARCHETTA, Grün



60 x 30 cm

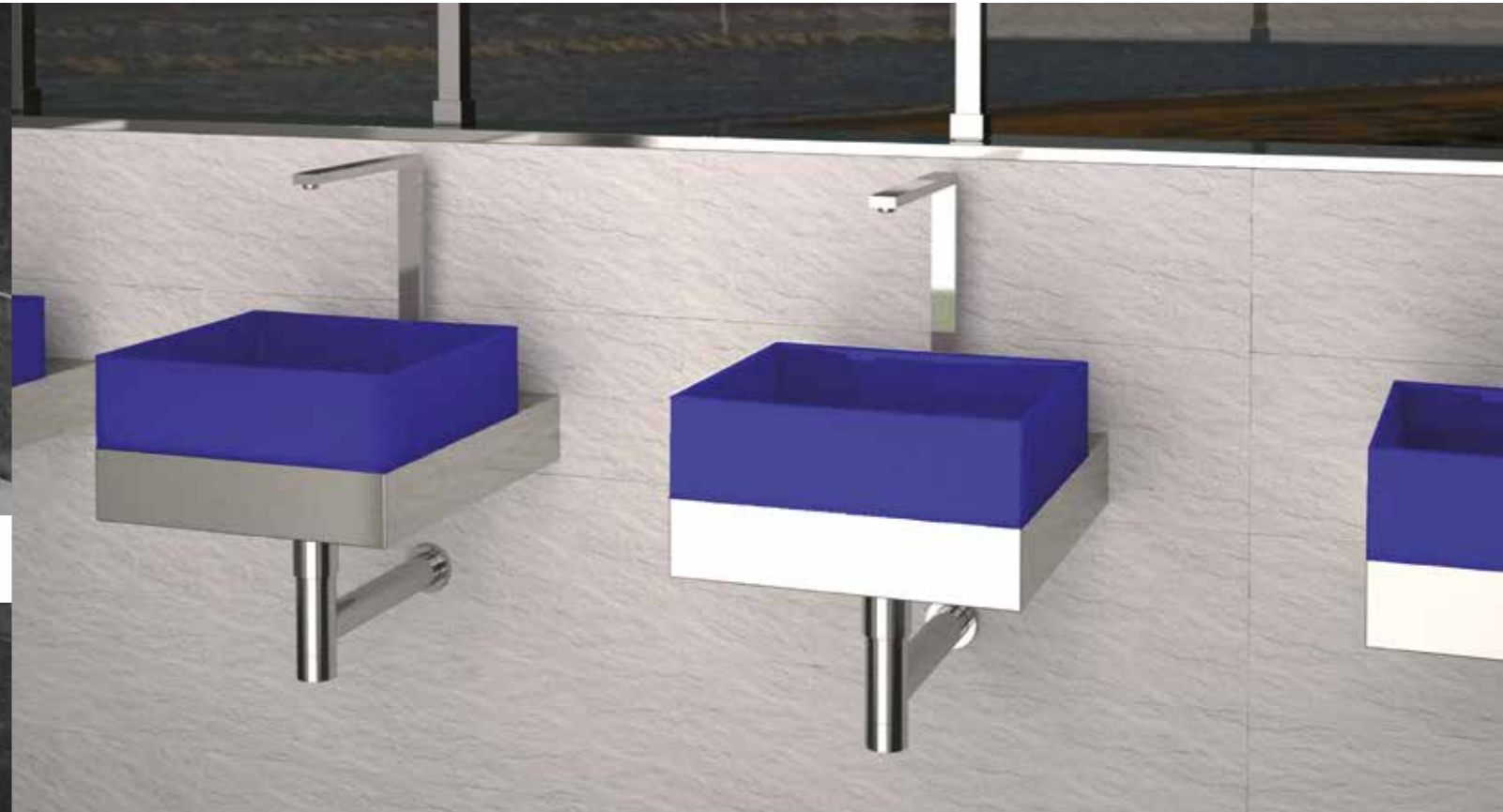

GUM, Blau



GUM, Weiß



GUM, Schwarz



GUM, Rot



GUM, Orange



GUM, Gelb



GUM, Violet



GUM, Pflaume



GUM, Alice-Blau



GUM, Blau

35 x 30 cm



STANDWASCHTISCHE

SKULPTURALE VIELFALT

Freistehende Waschtische von Glass Design haben einen skulpturalen Charakter. Inspiriert von der Welt der Mode sind diese Waschtische einzigartige Eyecatcher und dominieren den Raum. Diese außergewöhnlichen Produkte werden durch exklusive Farben und Oberflächen veredelt.

Alle Standwaschtische werden aus dem innovativen Werkstoff „Vetro-Freddo®“ gefertigt. Das mineralische Rohmaterial wird erhitzt, die flüssige Masse wird dann von Hand in die Beckenform gegossen. Nachdem das Material abgekühlt ist, werden alle Kanten und Radien von Hand nachbearbeitet. Die Farben und Oberflächen werden auch hier wieder von Hand aufgetragen. So wird z. B. das Blattgold Blatt für Blatt in drei Lagen auf das Becken aufgelegt und anschließend mit einer transparenten Glasur geschützt. Die neuen metallischen Oberflächen wie Alt-Inox und Alt-Messing werden sogar auf die Becken aufgemalt, somit ist jedes Becken ein Unikat.

AntiScratch – die innovative Schutzglasur wurde für den Einsatz in Hotels entwickelt. Alle Pert® Waschtische sind mit der AntiScratch Oberfläche veredelt. Durch diese zusätzliche Glasur wird das Becken für den täglichen Einsatz optimal geschützt.

PROTAGONISTEN FÜR IHR BAD.



FLOWER EVOLUTION, Gold (Blattauflage 3D)



FLOWER EVOLUTION, Rot



FLOWER EVOLUTION, Weiß

70 x 46 cm



DAME STANDWASCHTISCH, Gold (Blattauflage 3D)
DAME SPIEGEL, Gold (Blattauflage 3D)

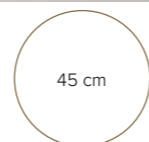

45 cm



DAME STANDWASCHTISCH, Schwarz
DAME SPIEGEL, Schwarz



DAME STANDWASCHTISCH, Blau-Violett, Lavendel,
Puder, Salbei-Grün, Gelb und Hellblau

45 cm



TOMMY METROPOLE, Schwarz matt/Anthrazit

42 cm

42 cm

TOMMY, Schwarz matt



AQUARAMA, Gold matt

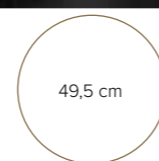

AQUARAMA, Bronze matt



KHORUS, Weiß glänzend

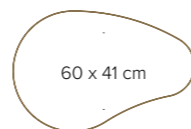

60 x 41 cm



KALICE, Weiß matt / Gold (Blattauflage 3D)



45 cm



SPAZIO, Ferrari Rot

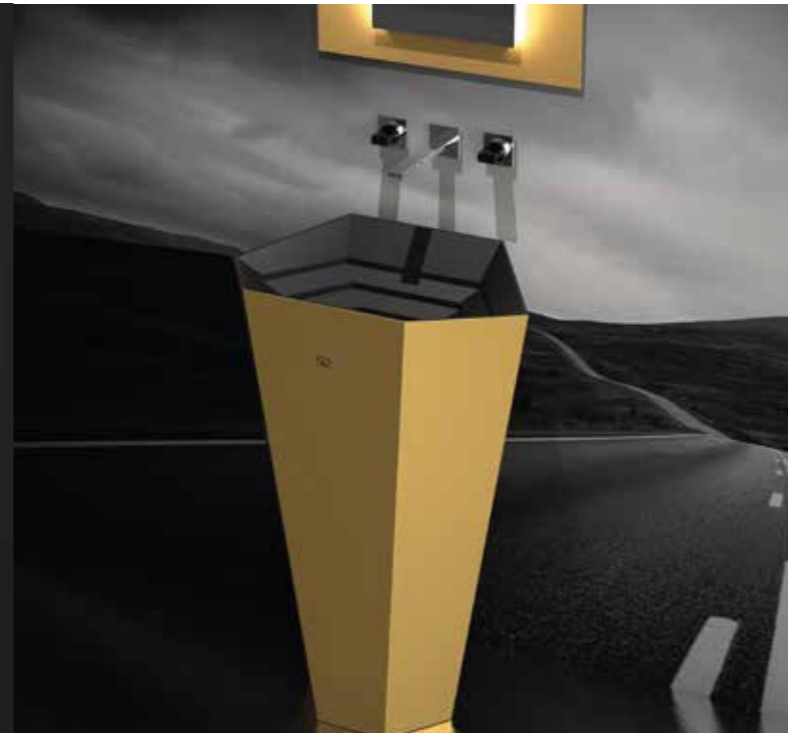
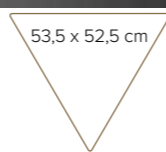

LAMBO, Schwarz / Gold matt

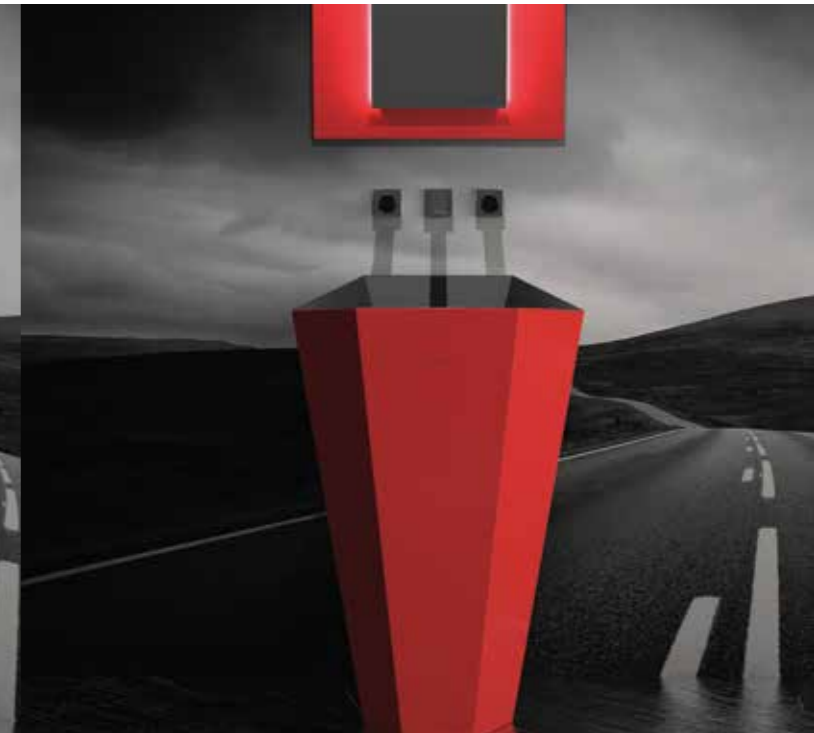

LAMBO, Schwarz / Rot



LAMBO, Schwarz / Grün

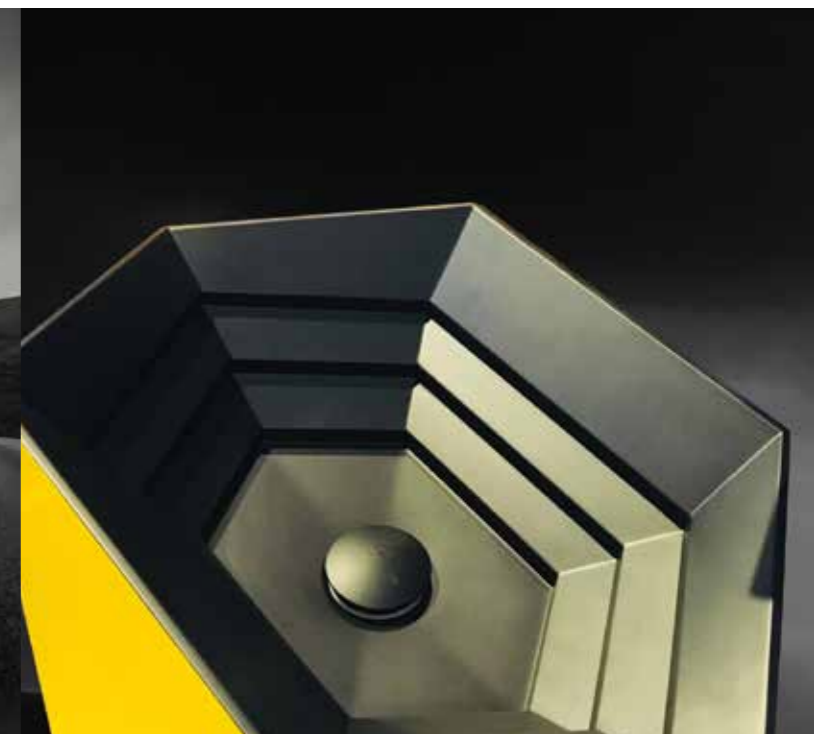

LAMBO, Schwarz / Gelb





UNIKO

METALLMÖBEL

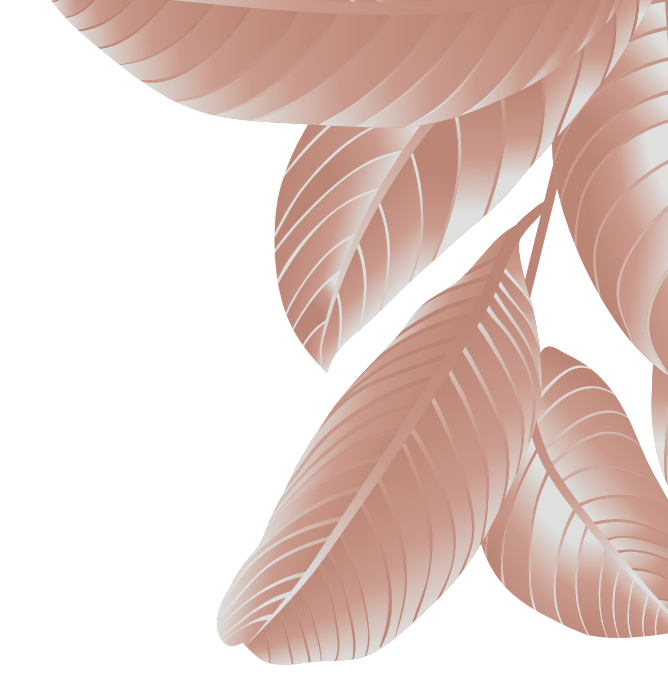

STATEMENT MIT ZEITGENÖSSISCHER ELEGANZ

Das UNIKO Metallmöbelprogramm ist ein einzigartiges Sortiment von Waschplatzlösungen. Minimalismus, Charme, Funktionalität und Vielseitigkeit verschmelzen zu einer Einheit. Der Kreativität sind keine Grenzen gesetzt. Sowohl für kleine Gäste-WCs als auch für große Badezimmer sind passende Lösungen im UNIKO Programm enthalten.

Die Waschplatzkonzepte begeistern mit funktionalen Details wie Handtuchhalter und Ablagen. Das Accessoires-Programm ARIA und die Metallspiegel sind auf das Sortiment in Form, Oberfläche und Größe abgestimmt.

INSPIRIERENDES GEFÜHL VON
DESIGN UND LUXUS.



TONDO COMPACT, Schwarz/Schwarz matt



TONDO COMPACT, Schwarz/Weiß matt



TONDO PLUS, Altmessing/Schwarz matt

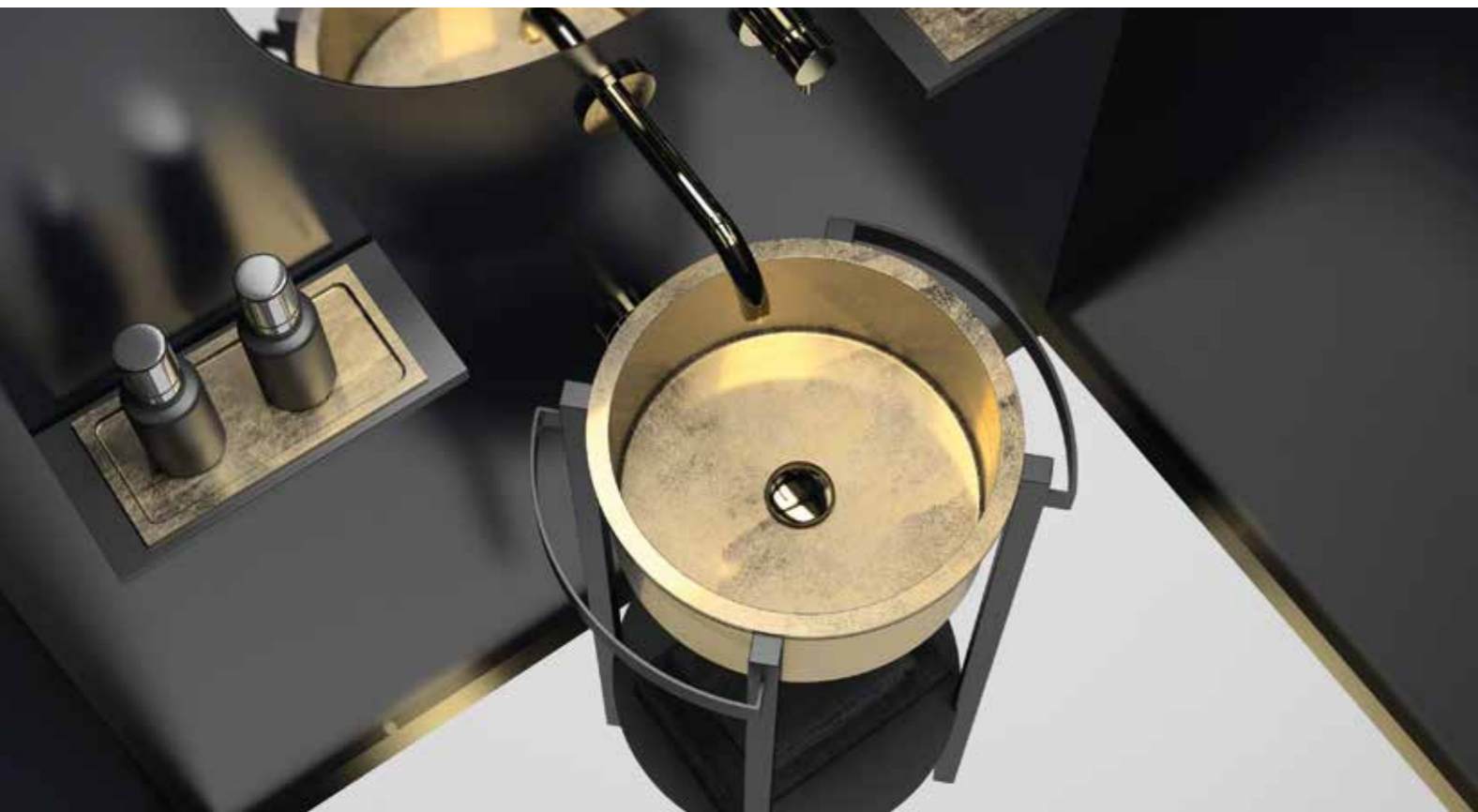

TONDO PLUS, Schwarz matt/Blattauflage Gold 3D



TONDO PLUS, Schwarz/Weiß matt
TONDO 60, Metallspiegel | ARIA UNO, Ablage Schwarz/Blattauflage Silber 3D

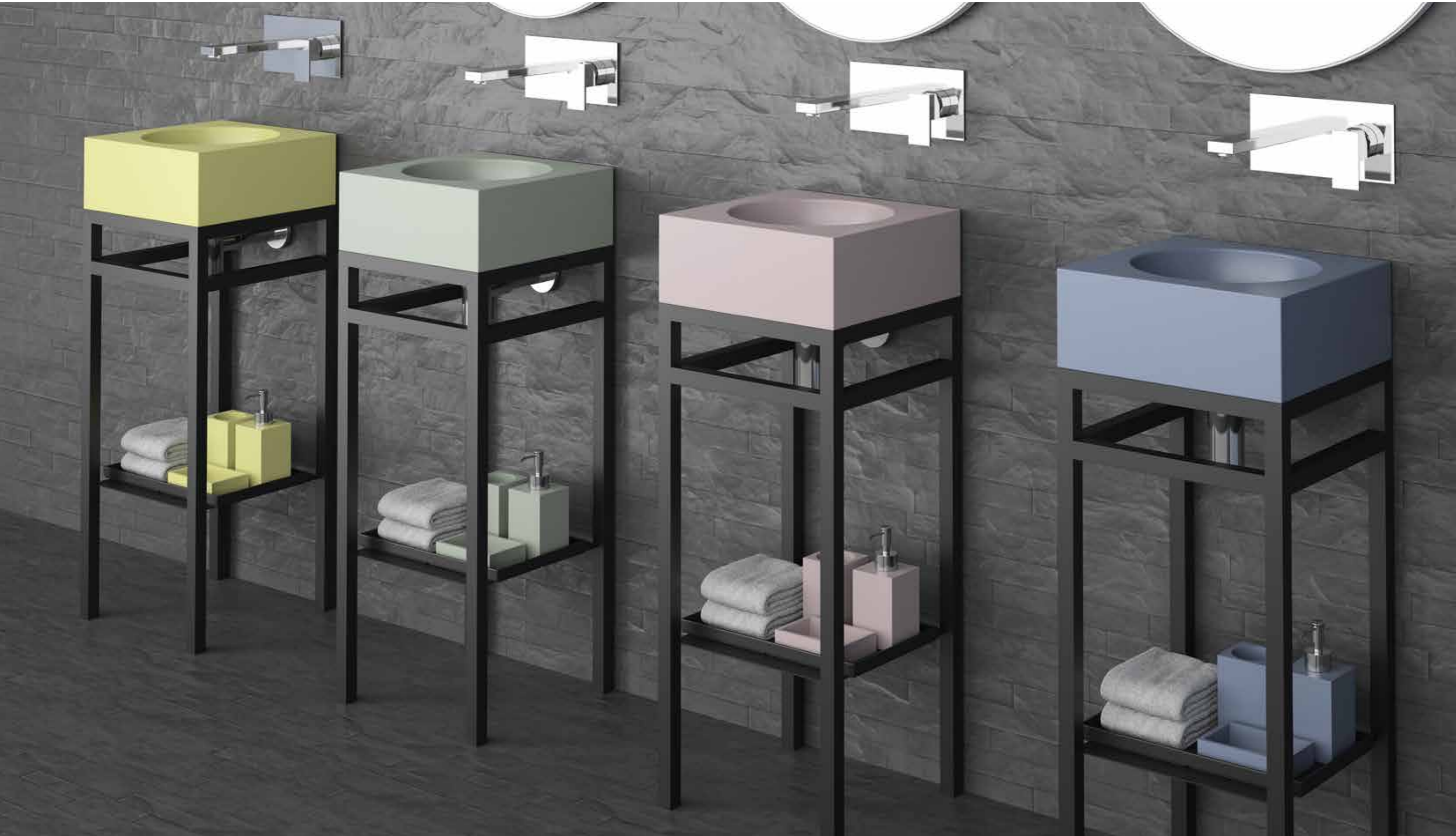

ONE PLUS, Schwarz
ONE, Gelb matt/Salbei matt/Puder Pink matt/Avio matt



BLOOM PLUS, Schwarz
ROSE 34, Schwarz matt



BLOOM PLUS, Weiß
ROSE 34, Weiß matt



MOVE PLUS, Schwarz
METROPOLE KATINO, Platin



MOVE PLUS, Schwarz
ROSE LUX, Kupfer



ELLE PLUS, Altmessing/Schwarz matt



ELLE PLUS, Schwarz/Gold (Blattauflage 3D)



ELLE PLUS, Schwarz/Gold (Blattauflage 3D)



ITALY PLUS, Schwarz/Schwarz matt



ITALY PLUS, Weiß/Alt Messing



BADEWANNEN



MEISTERWERKE – IM LUXUS BADEN

Die Badewannen von Glass Design sind besondere Unikate für Ihr Bad.

Unvergleichliche Solitäre, die wie ein Kunstwerk das Bad bereichern. Durch besondere Veredelungen wie Blattauflagen oder Lackierungen passen sich diese Badewannen ihrem Wohnstil an.

EINDRUCKSVOLLER MITTELPUNKT IM BAD.



FLOWER STYLE, Schwarz matt / Weiß matt



FLOWER STYLE, Gold (Blattaufgabe 3D) / Weiß matt

175,2 x 83,5 cm





MINI STYLE, Weiß matt

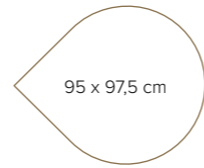

MINI STYLE, Weiß matt

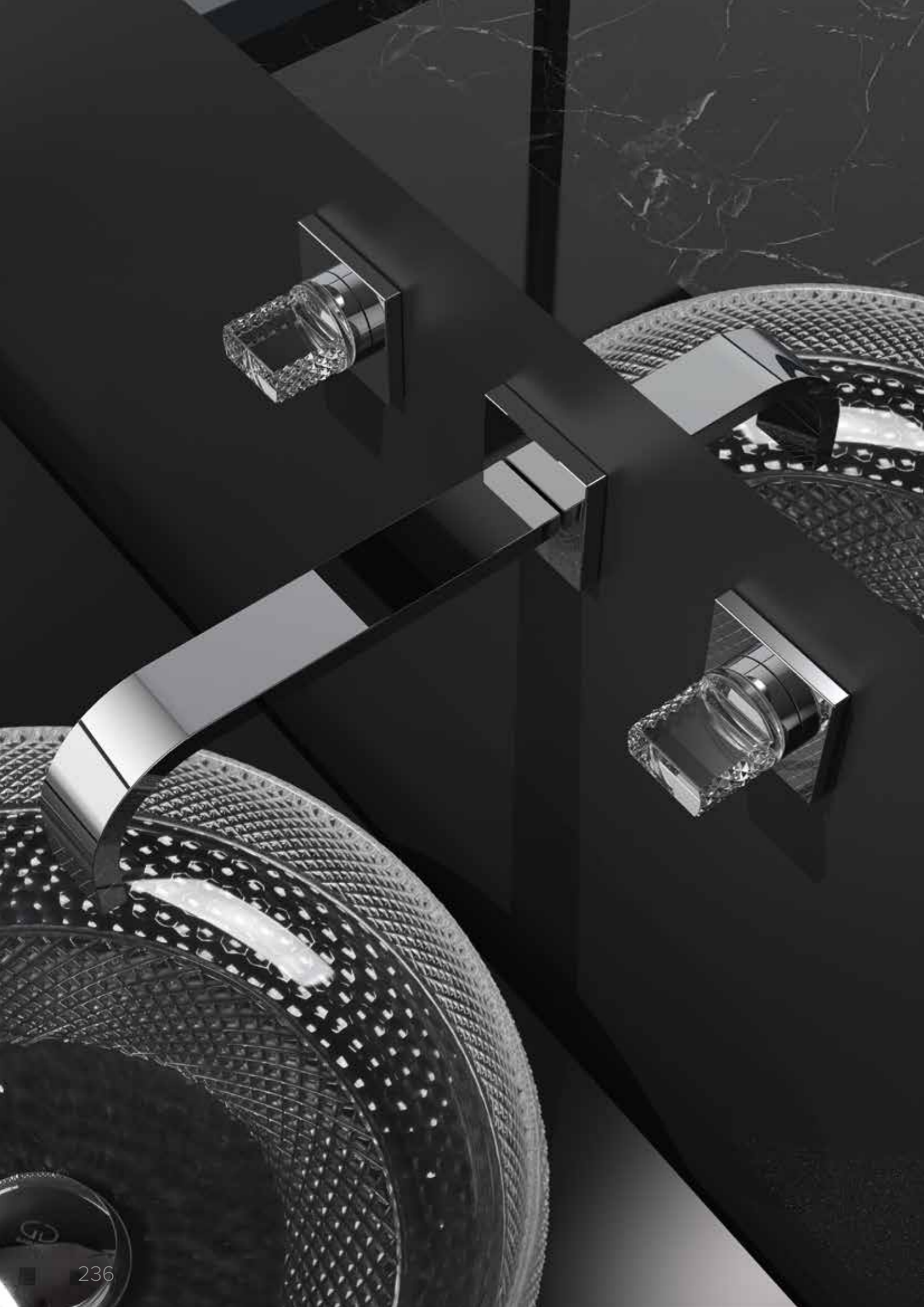

Glamorous TUNING

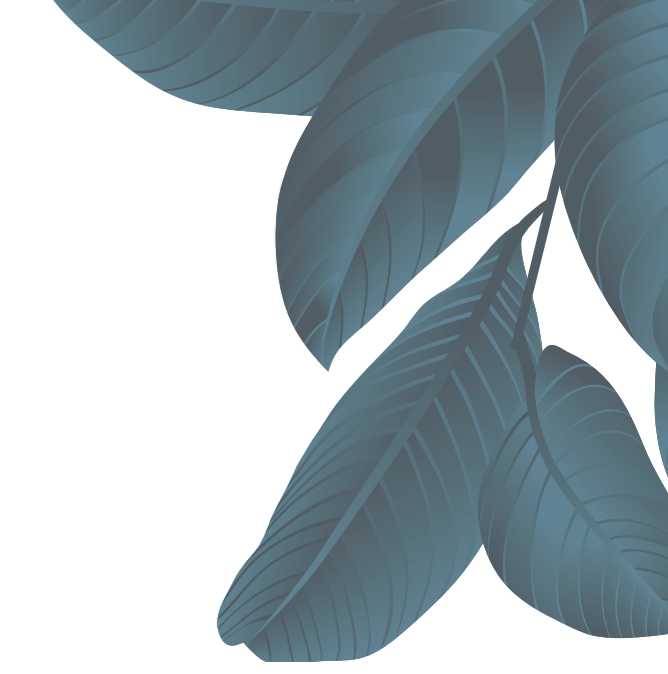

EXKLUSIVE GLAMOROUS TUNING ARMATURENGRIFFE

Von klassisch elegant bis puristisch modern – entdecken Sie Glamorous Tuning. Kombinieren Sie deutsches Know-how mit italienischem Design. Die Designs der Griffe harmonieren perfekt mit den Waschtischen von Glass Design, lassen sich aber auch auf vielen anderen Waschplätzen in Szene setzen. Individualisieren Sie Ihren Waschplatz mit einzigartigen und individuellen Kompositionen. Die Griffkollektion lässt sich mit unterschiedlichen Dornbracht Armaturenserien kombinieren.

Diese äußerst raffinierten Produkte werden von unseren Meisterkünstlern nach den ältesten und edelsten Glaskünsten aus 24% Bleikristallglas in aufwendiger Handarbeit gefertigt. Dabei werden weder Maschinen noch andere Technologien eingesetzt.

**DORN
BRACHT** ENTSTANDEN IM RAHMEN EINER
TECHNISCHEN KOOPERATION



GLAMOROUS
NATÜRLICH FASZINIEREND



TOWER
SCHLICHTE ELEGANZ



REGENTS
ELEGANTES STATEMENT



LYRIC
SKULPTUR AUS KRISTALL





ICE OVAL, Transparent
GLAMOROUS ICE XL, Transparent/Messing matt



RAMADA, Transparent
GLAMOROUS RAMADA XL, Transparent/Messing matt



LUXOR OVAL, Transparent
GLAMOROUS LUXOR XL, Transparent/Chrom



CLIVIA, Transparent
GLAMOROUS CLIVIA XL, Transparent/Chrom

TOWER ICE

TOWER ICE SMALL



TOWER ICE, Transparent/Chrom

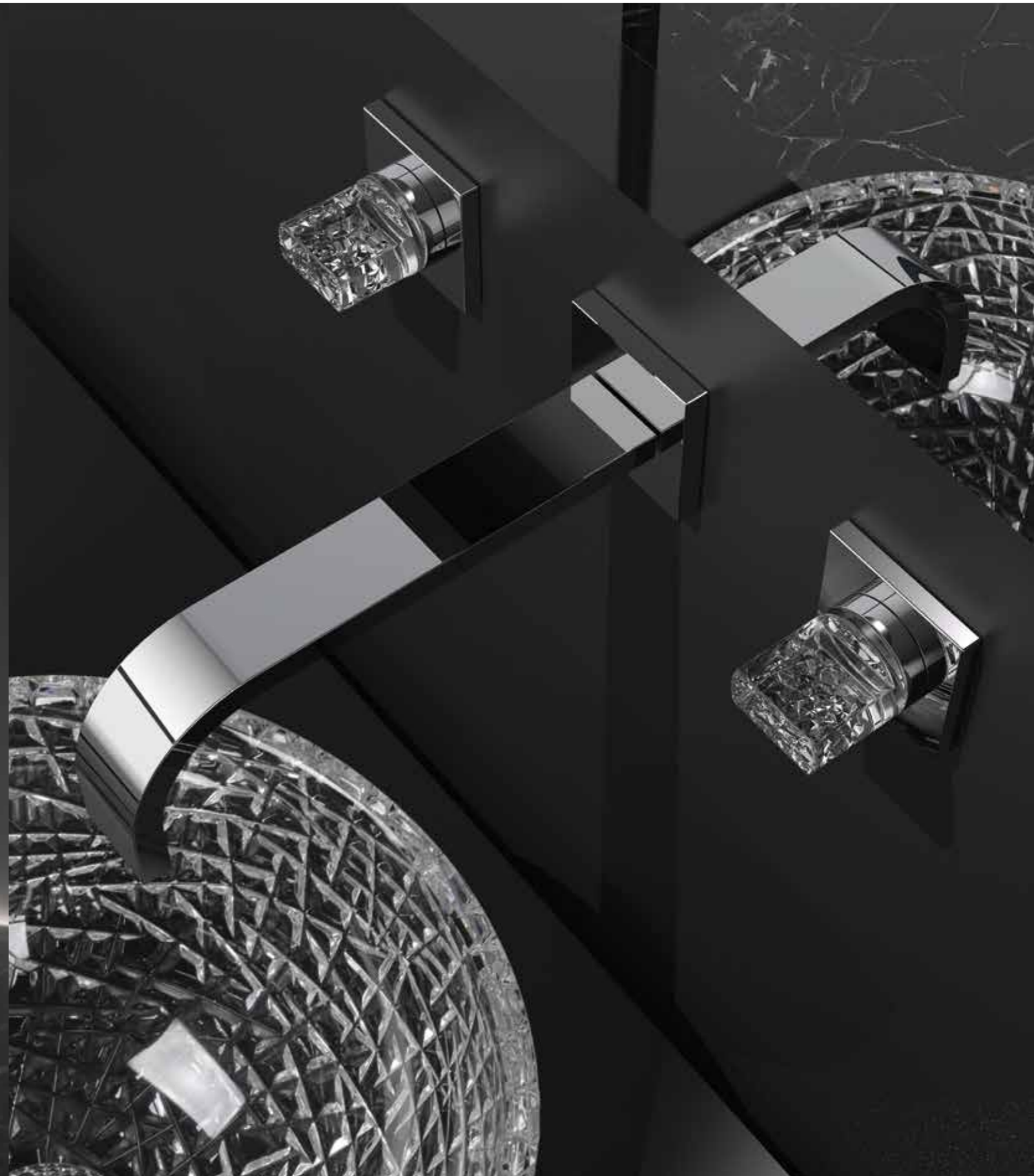

TOWER ICE SMALL, Transparent/Chrom

TOWER RAMADA

TOWER RAMADA SMALL

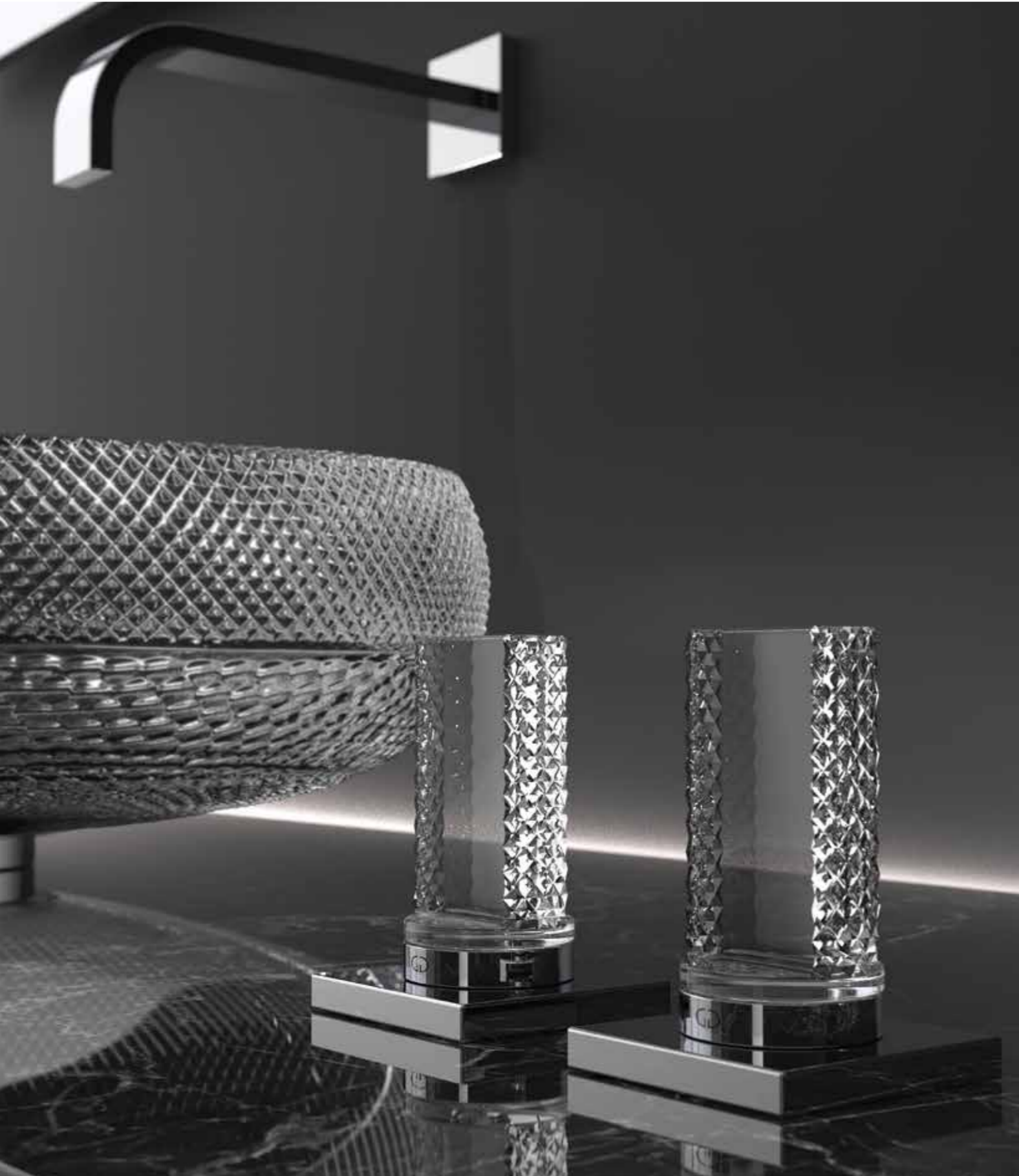

TOWER RAMADA, Transparent/Chrom

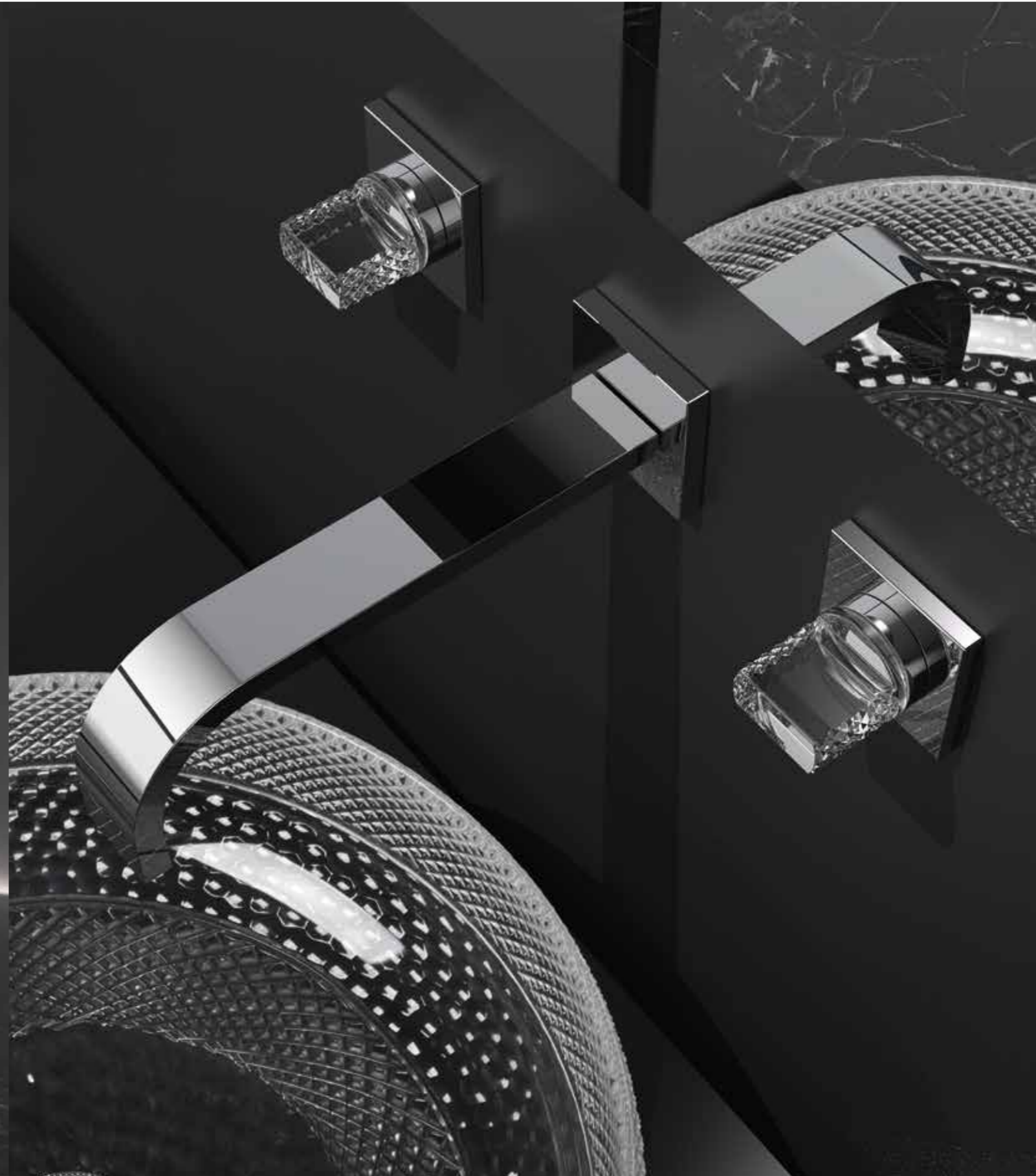

TOWER RAMADA SMALL, Transparent/Chrom

TOWER CLIVIA

TOWER CLIVIA SMALL

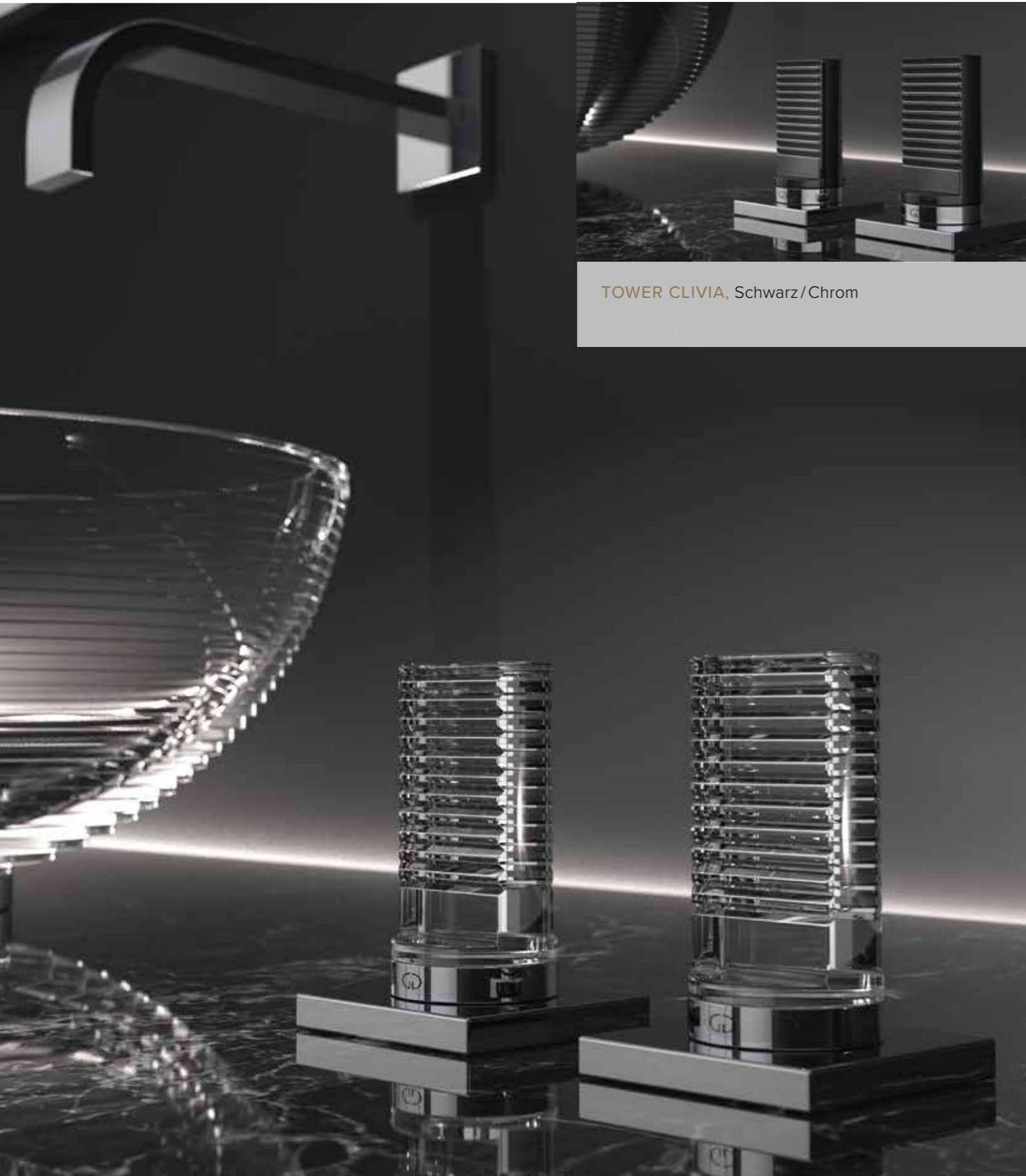

TOWER CLIVIA, Schwarz/Chrom

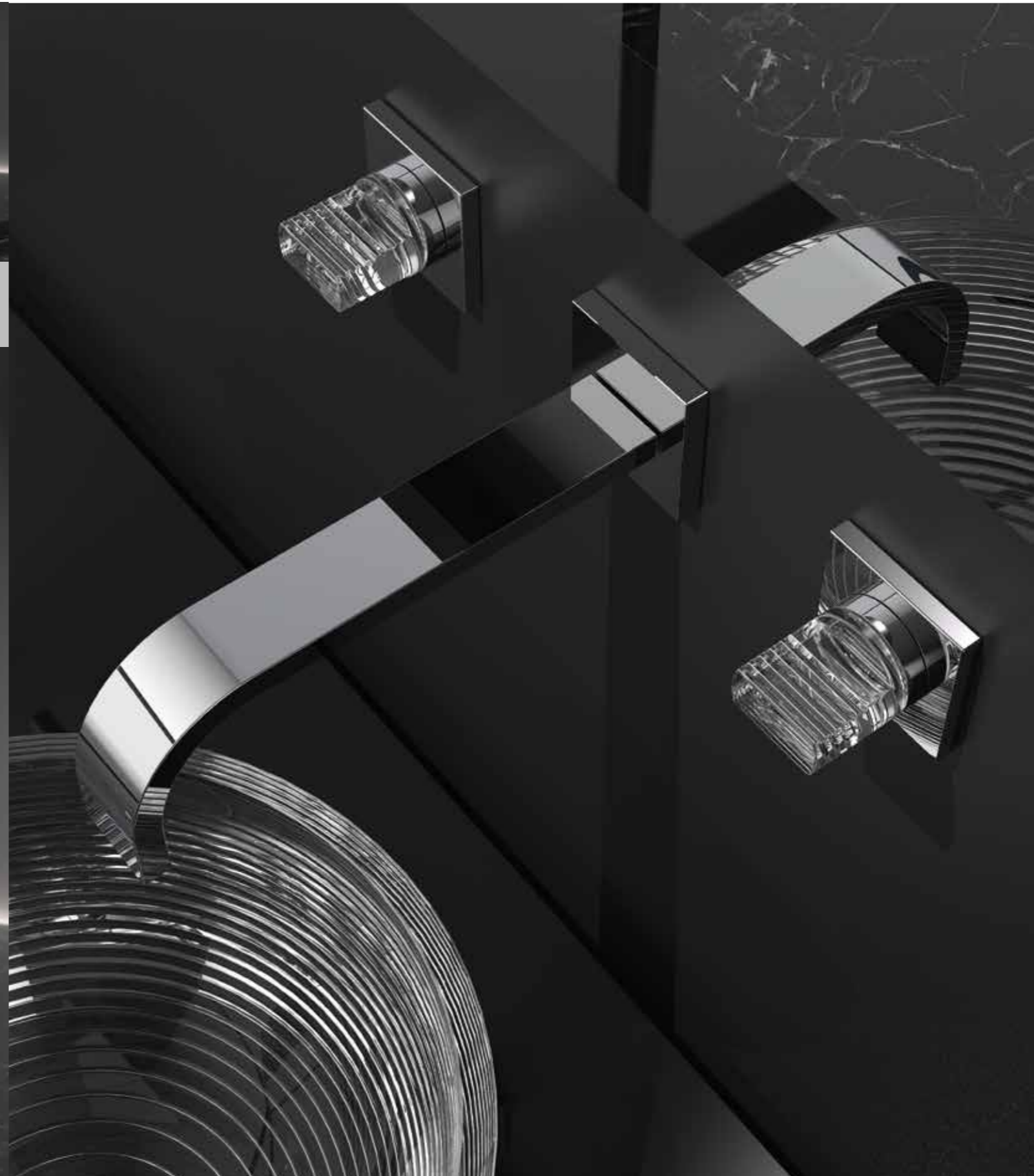

TOWER CLIVIA, Transparent/Chrom

TOWER CLIVIA SMALL, Transparent/Chrom

TOWER



TOWER, Schwarz/Chrom

TOWER SMALL



TOWER SMALL, Schwarz/Chrom

TOWER MARBLE

TOWER MARBLE SMALL



TOWER MARBLE, Marquina/Chrom

TOWER MARBLE, Calacatta/Chrom



TOWER MARBLE SMALL, Marquina/Chrom



REGENTS QUEEN XL, Schwarz/Messing matt



REGENTS KING SMALL, Schwarz/Chrom



LYRIC ICE, Transparent/Gold-Chrom

LYRIC RAMADA



LYRIC RAMADA, Transparent/Gold-Chrom

LYRIC CLIVIA



LYRIC CLIVIA, Transparent/Silber-Chrom

LYRIC METROPOLE

LYRIC LUXOR



LYRIC METROPOLE, Transparent/Platin-Chrom



LYRIC METROPOLE, Transparent/Anthrazit-Chrom



LYRIC LUXOR, Transparent/Gold-Chrom



LYRIC, Transparent/Schwarz-Schwarz matt



LYRIC PREMIUM, Transparent/Gold-Messing matt



LYRIC MARBLE, Calacatta/Messing matt



LYRIC MARBLE, Marquina/Chrom

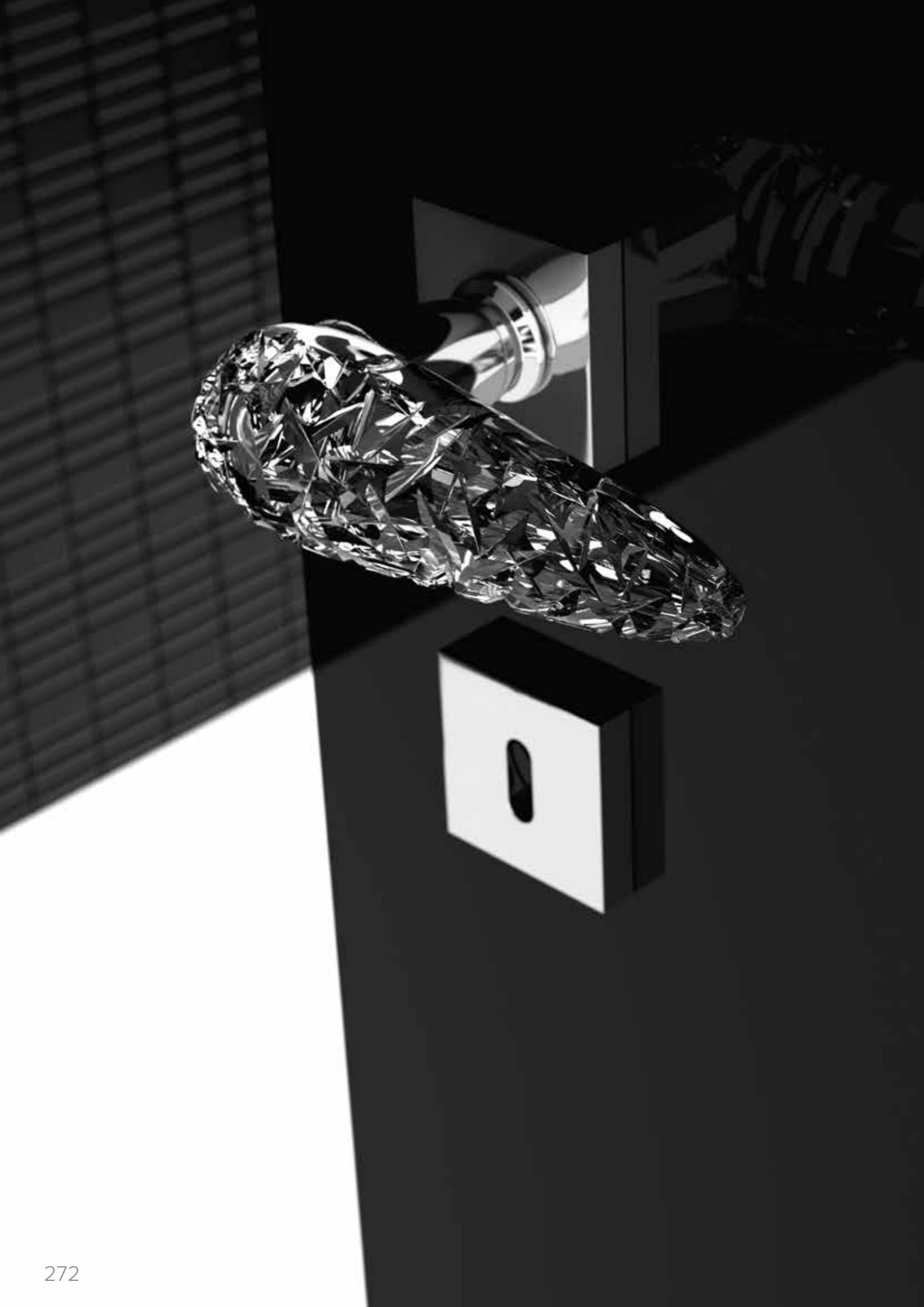

ARIUS®
H O M E



UNIKATE FÜR INDIVIDUALISTEN

Das ARIUS® HOME Konzept umfasst Tür- und Möbelgriffe, Griffe für Glas-Duschabtrennungen sowie Kleiderhaken.

Diese außergewöhnlichen Produkte können in Bezug auf Farbe, Form, Materialität und Stil untereinander und mit der gesamten Glass Design Produktpalette, also insbesondere Waschtischlösungen, kombiniert werden.

Entdecken Sie die nahezu grenzenlose Auswahl auf www.myglassdesign.de

DER EINTRITT ZUM AUFTRITT.



GOCCIA, Weiß/Gold



CUOIO 30, Schwarzes Leder/Chrom



KYMI HOME, Transparent/Chrom



PRINCESS, Transparent/Gold



ACCESSOIRES



FÜR EIN STRAHLENDES LÄCHELN

Mit den Accessoires von Glass Design sorgen Sie für Furore in Ihrem Bad.

Egal ob mit den eleganten Valentino Accessoires, den perfekt auf die Waschtischkollektionen abgestimmten Accessoires Sets, oder als besonderes Highlight die Royal Kollektion. Die Kollektionen umfassen die unterschiedlichen Werkstoffe von GlassDesign.

PERFEKTE DETAILS FÜR EINZIGARTIGE BÄDER.



OPERA und CANTO, WC-Bürstengarnitur, Transparent mit verschiedenen Schlifffen



ROYAL, Seifenspender, Light Gold / Schwarz matt



ROYAL, Seifenspender, Transparent / Weiß matt



ROYAL, Seifenspender, Bronze / Schwarz matt



ROYAL, Seifenspender, Dark Inox / Schwarz matt

VALENTINO

ACCESSOIRES

ARIA



VALENTINO, Schwarz



VALENTINO, Weiß



ARIA UNO, Ablage mit Einsatz, Schwarz matt/Blattsilber

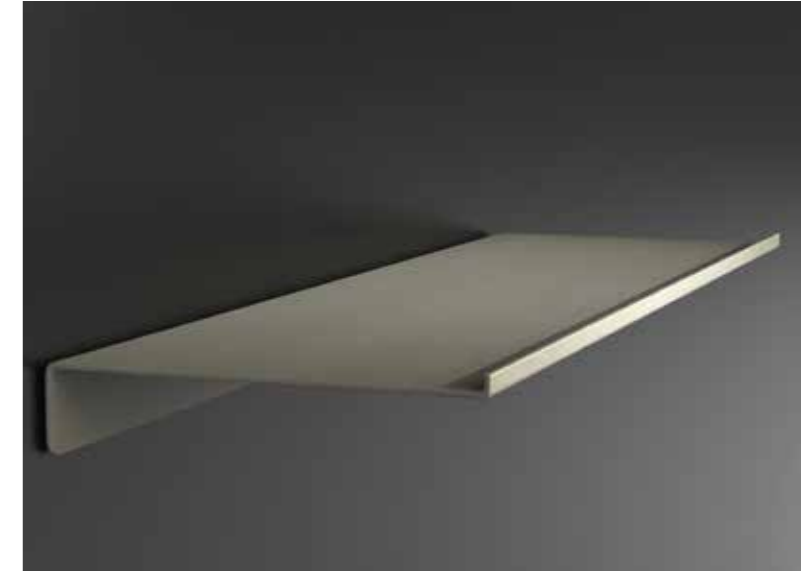

ARIA TRE, Ablage, Altmessing



VALENTINO, Transparent

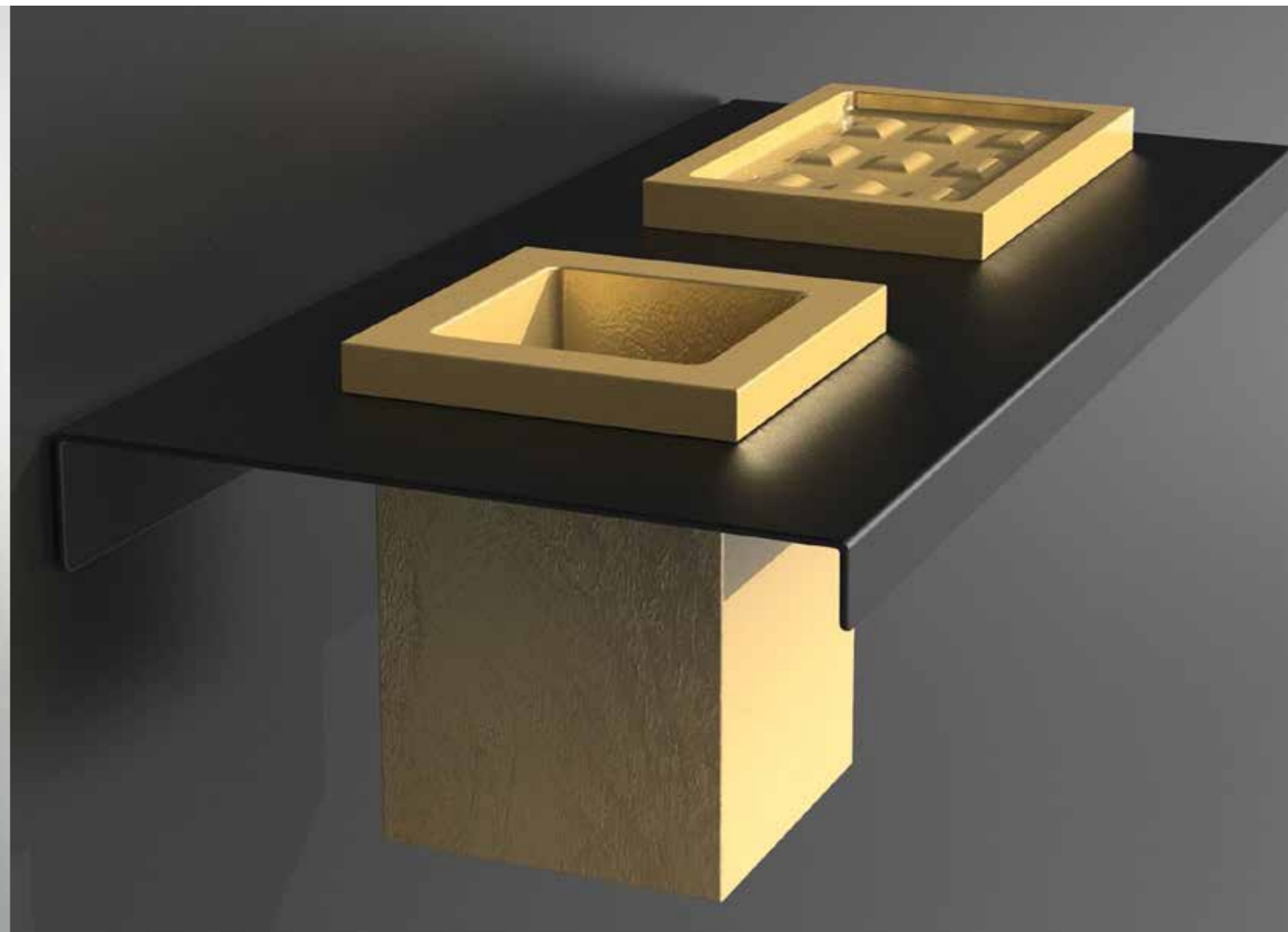

ARIA DUE, Ablage mit Becher und Seifenschale, Schwarz matt/Blattgold

METROPOLE

ACCESSOIRES

LINEA



METROPOLE, Bronze



METROPOLE, Silber



LINEA, Ottonio

LINEA, Ingwer

LINEA, Rubinrot



METROPOLE, Platin



LINEA, Gewittergrau

GRAFFITI 2

ACCESSOIRES

LUNA



GRAFFITI 2, Schwarz/Gold/Elfenbein

GRAFFITI 2, Weiß/Gold



GRAFFITI 2, Rot/Gold/Elfenbein

GRAFFITI 2, Silber/Schwarz



LUNA, Grau

LUNA, Sand



LUNA, Weiß



LUXURY, Blattgold



MODE LUX, Silber



MODE LUX, LIGHT-Gold



MODE LUX, Bronze



MODE LUX, Inox



NAVY, Schwarz matt



CARRARA, Calacatta Weiß



KOOL, Weiß matt



CARRARA, Marquina Schwarz



SORTIMENTSÜBERSICHT

EYECATCHER FÜR IHR BAD

Die große Material- und Farbauswahl bietet einen nahezu unbegrenzten Gestaltungsspielraum in der Inszenierung des Waschplatzes. Ob handgefertigte Kristallglaswaschtische, extrovertierte Modelle aus Marmor oder die in nahezu unbegrenzter Farbauswahl lieferbaren Modelle aus VetroFreddo: Im Produktportfolio von GlassDesign findet jeder Designliebhaber ein passendes Modell.

GlassDesign bietet Waschtische aus insgesamt acht unterschiedlichen Materialien an. Diese hohe Modell- und Materialvielfalt hat den großen Vorteil, dass nahezu alle Kundenwünsche im Bereich der Aufsatzwaschtische abgedeckt werden.

GESTALTUNGSSPIELRAUM OHNE GRENZEN.

Technische Informationen und Montageanleitungen zu den Produkten entnehmen Sie bitte dem entsprechenden Datenblatt auf unserer Homepage myglassdesign.de/produkte.



ICE OVAL SMALL

- Material: Bleikristall 24%pb
- Gewicht: 4,0 kg
- Maße: Ø 435 x 290 mm x 138 mm
- Lochbohrung: Ø 45 mm

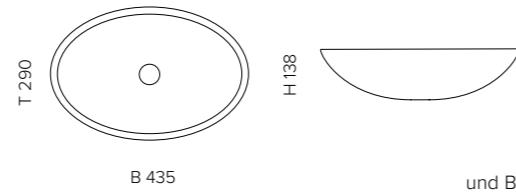

inkl. Ablaufventil
und Basisring Chrom bzw. Gold



Transparent / Chrom
ICEOVSMST01F4



Schwarz / Chrom
ICEOVSMST30F4AS



Transparent / Gold
ICEOVSMST01F3



Schwarz / Gold
ICEOVSMST30F3AS

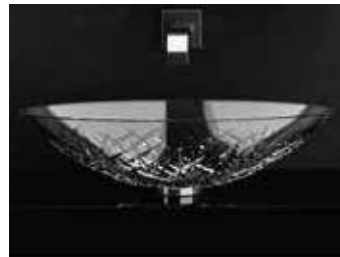

ICE OVAL

- Material: Bleikristall 24%pb
- Gewicht: 6,40 kg
- Maße: B 510 x T 345 x H 150 mm
- Lochbohrung: Ø 45 mm

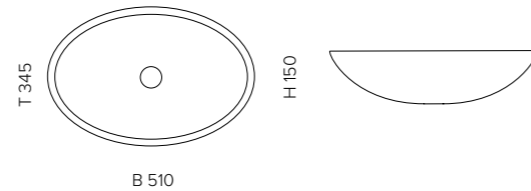

inkl. Ablaufventil
und Basisring Chrom bzw. Gold



Transparent
ICEOVT01F4



Transparent / Gold
ICEOVT01F3



ICE OVAL LUX

- Material: Bleikristall 24%pb
- Gewicht: 6,40 kg
- Maße: B 510 x T 345 x H 150 mm
- Lochbohrung: Ø 45 mm

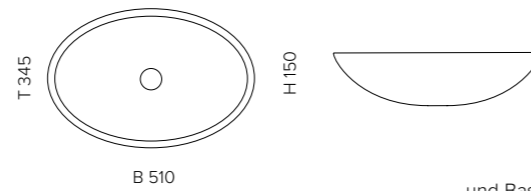

inkl. Ablaufventil
und Basisring Chrom bzw. Gold



Gold + Ablaufventil /
Basisring-Gold
ICEOVGDF3AS



Gold + Ablaufventil /
Basisring-Chrom
ICEOVGDF4AS



Silber + Ablaufventil /
Basisring-Chrom
ICEOVSLF4AS



Platin + Ablaufventil /
Basisring-Chrom
ICEOVPLF4AS



Bronze + Ablaufventil /
Basisring-Chrom
ICEOVBF4AS



ICE OVAL XL

- Material: Bleikristall 24%pb
- Gewicht: 7,80 kg
- Maße: B 560 x T 380 x H 150 mm
- Lochbohrung: Ø 45 mm

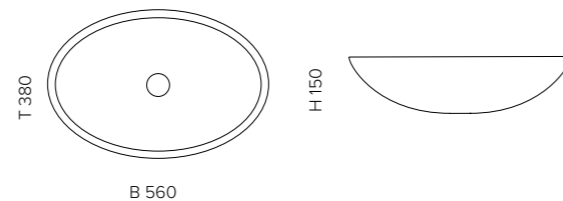

inkl. Ablaufventil
und Basisring Chrom bzw. Gold



Transparent + Ablaufventil /
Basisring-Chrom
ICEOVXLT01F4



Transparent + Ablaufventil /
Basisring-Gold
ICEOVXLT01F3



ICE OVAL LUX XL

- Material: Bleikristall 24%pb
- Gewicht: 7,80 kg
- Maße: B 560 x T 380 x H 150 mm
- Lochbohrung: Ø 45 mm

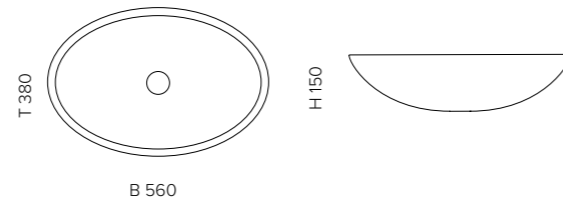

inkl. Ablaufventil
und Basisring Chrom



Gold + Ablaufventil /
Basisring-Gold
ICEOVXLGDF3AS



Gold + Ablaufventil /
Basisring-Chrom
ICEOVXLGDF4AS



Silber + Ablaufventil /
Basisring-Chrom
ICEOVXLSLF4AS



Bronze + Ablaufventil /
Basisring-Chrom
ICEOVXLBZF4AS



Platin + Ablaufventil /
Basisring-Chrom
ICEOVXLPLF4AS

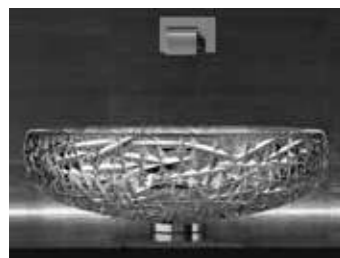

SCENIC ICE

- Material: Bleikristall 24%pb
- Gewicht: 7,10 kg
- Maße: Ø 440 x H 136 mm
- Lochbohrung: Ø 45 mm

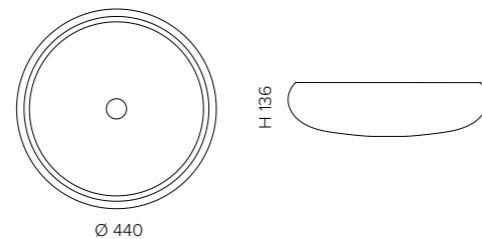

inkl. Ablaufventil
und Basisring Chrom



Transparent
SCENICET01F4



Rubinrot
SCENICET16F4



Cobaltblau
SCENICET18F4



Smaragdgrün
SCENICET22F4



Gewittergrau
SCENICET45F4

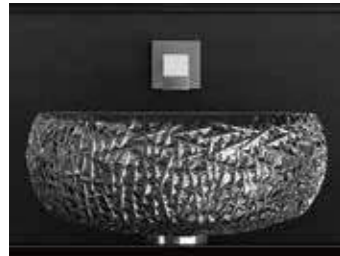

GLO BALL CRYSTAL ICE

- Material: Bleikristall 24%pb
- Gewicht: 19,20 kg
- Maße: Ø 420 x H 186 mm
- Lochbohrung: Ø 45 mm

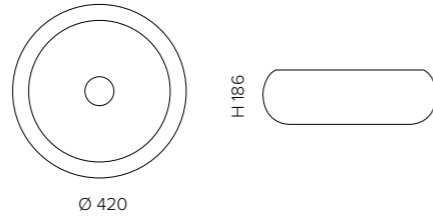

inkl. Ablaufventil
und Basiring Chrom



Transparent
GLOBALLICET01

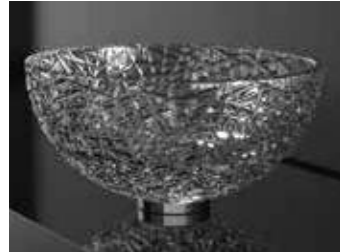

ICE ROUND 34

- Material: Bleikristall 24%pb
- Gewicht: 7,50 kg
- Maße: Ø 340 x H 170 mm
- Lochbohrung: Ø 45 mm

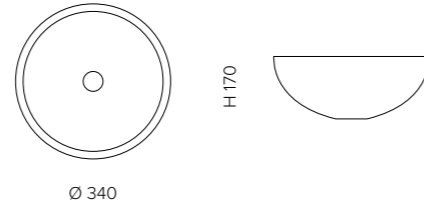

inkl. Ablaufventil
und Basiring Chrom



Transparent
ICERO34T01



ICE ROUND 34 LUX

- Material: Bleikristall 24%pb
- Gewicht: 7,50 kg
- Maße: Ø 340 x H 170 mm
- Lochbohrung: Ø 45 mm

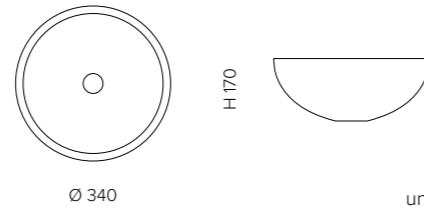

inkl. Ablaufventil
und Basiring Chrom bzw. Gold



Gold (Ablaufventil Gold)
ICE34GDF3AS



Gold (Ablaufventil Chrom)
ICE34GDF4AS



Silber
ICE34SLF4AS



Platin
ICE34PLF4AS



Bronze
ICE34BZF4AS



ICE ROUND

- Material: Bleikristall 24%pb
- Gewicht: 7,5 kg
- Maße: Ø 435 x H 175 mm
- Lochbohrung: Ø 45 mm

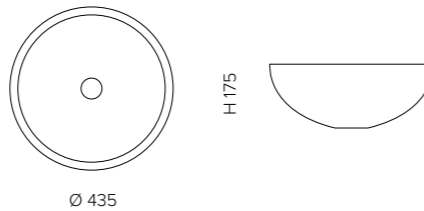

inkl. Ablaufventil
und Basiring Chrom



Transparent
ICEROT01

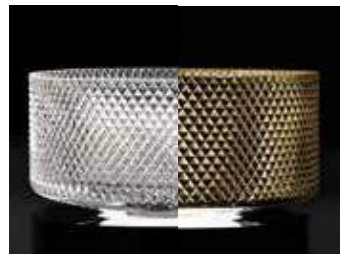

VILLA VILLA LUX

- Material: Kristallglas
- Gewicht: 9,0 kg
- Maße: Ø 330 x H 180 mm
- Lochbohrung: Ø 45 mm

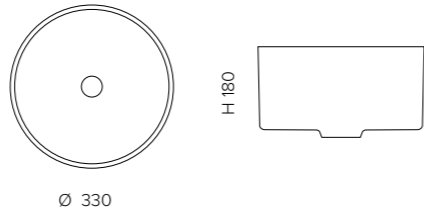

inkl. Ablaufventil
Chrom bzw. Gold



Transparent (Ablaufventil Chrom)
VILLAT01F4



Gold (Ablaufventil Gold)
VILLAGDF3AS



VOLÉ SOLE

- Material: Kristallglas
- Gewicht: 9,7 kg
- Maße: Ø 430 x H 180 mm
- Lochbohrung: Ø 45 mm

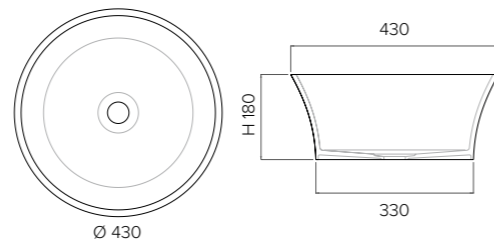

inkl. Ablaufventil Chrom



Transparent
VOLESOLE01F4



GIOTTO

- Material: Kristallglas
- Gewicht: 9,0 kg
- Maße: Ø 330 x H 180 mm
- Lochbohrung: Ø 45 mm

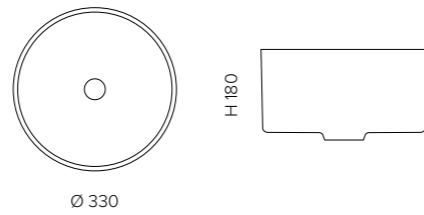

inkl. Ablaufventil Chrom



Transparent
GIOTTOT01F4



VOLÉ GIOTTO

- Material: Kristallglas
- Gewicht: 9,7 kg
- Maße: Ø 430 x H 180 mm
- Lochbohrung: Ø 45 mm

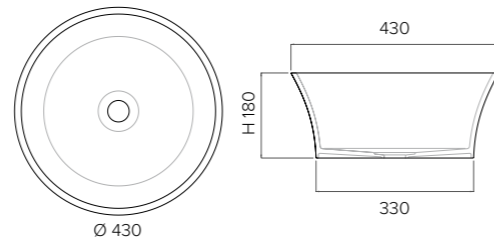

inkl. Ablaufventil Chrom



Transparent
VOLEGIOTTOT01F4



LUXOR ROUND

- Material: Bleikristall 24%pb
- Gewicht: 7,0 kg
- Maße: Ø 435 x H 160 mm
- Lochbohrung: Ø 45 mm

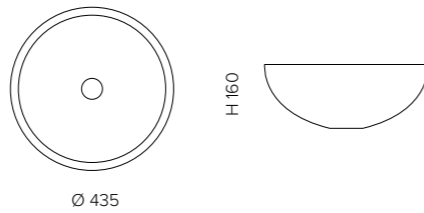

inkl. Ablaufventil
und Basisring Chrom



Transparent
LUXORROT01F4



LUXOR OVAL

- Material: Bleikristall 24%pb
- Gewicht: 7,5 kg
- Maße: B 510 x T 345 x H 155 mm
- Lochbohrung: Ø 45 mm

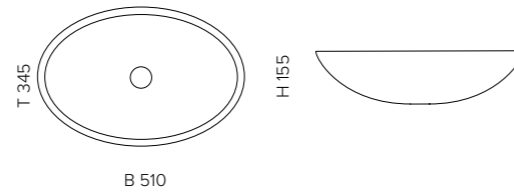

inkl. Ablaufventil
und Basisring Chrom

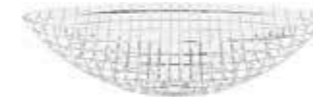

Transparent
LUXOROVT01F4



COLLIER

- Material: Bleikristall 24%pb
- Gewicht: 7,35 kg
- Maße: B 510 x T 345 x H 185 mm
- Lochbohrung: Ø 45 mm

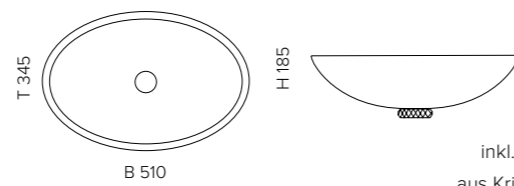

inkl. transparentem Basisring
aus Kristallglas und Ablaufventil



Schwarz mit transparentem Basisring
COLLIERT30



RAMADA

- Material: Bleikristall 24%pb
- Gewicht: 7,5 kg
- Maße: Ø 340 x H 150 mm
- Lochbohrung: Ø 45 mm

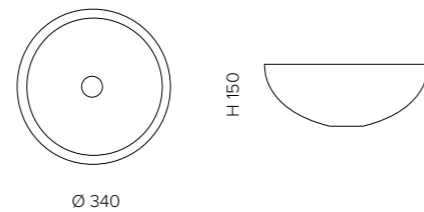

inkl. Ablaufventil
und Basisring Chrom



Transparent
RAMADAT01F4



RAMADA LUX

- Material: Bleikristall 24%pb
- Gewicht: 7,50 kg
- Maße: Ø 340 x H 150 mm
- Lochbohrung: Ø 45 mm

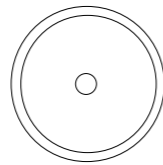

Ø 340

H 150

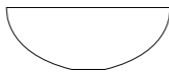

inkl. Ablaufventil
und Basisring Chrom bzw. Gold



Gold (Ablaufventil Gold)
RAMADAGDF3AS



Gold (Ablaufventil Chrom)
RAMADAGDF4AS



Silber
RAMADASLF4AS



Bronze
RAMADABZF4AS



Platin
RAMADAPLF4AS



SCENIC RAMADA

- Material: Bleikristall 24%pb
- Gewicht: 8,90 kg
- Maße: Ø 440 x H 136 mm
- Lochbohrung: Ø 45 mm

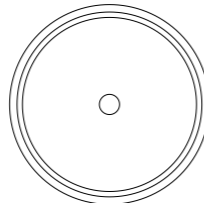

Ø 440

H 136



inkl. Ablaufventil
und Basisring Chrom



Transparent
SCENICRAMT01F4



Rubinrot
SCENICRAMT16F4



Cobaltblau
SCENICRAMT18F4



Smaragdgrün
SCENICRAMT22F4



Gewittergrau
SCENICRAMT45F4



CLIVIA

- Material: Bleikristall 24%pb
- Gewicht: 6,70 kg
- Maße: Ø 400 x H 130 mm
- Lochbohrung: Ø 45 mm

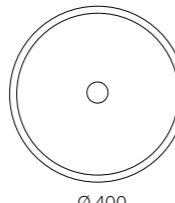

Ø 400

H 130

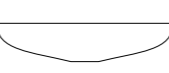

inkl. Ablaufventil
und Basisring Chrom



Transparent
CLIVIAT01



Schwarz
CLIVIAT35



CHELO

- Material: Bleikristall 24%pb
- Gewicht: 7,50 kg
- Maße: Ø 340 x H 170 mm
- Lochbohrung: Ø 45 mm

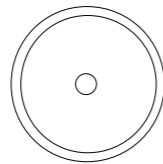

Ø 340

H 170

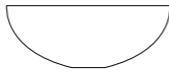

inkl. Ablaufventil
und Basisring Chrom



Transparent
CHELOT01



Schwarz
CHELOT30



VOLTA 34

- Material: Bleikristall 24%pb
- Gewicht: 7,45 kg
- Maße: Ø 340 x H 170 mm
- Lochbohrung: Ø 45 mm

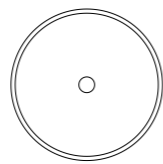

Ø 340

H 170

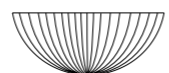

inkl. Ablaufventil
und Basisring Chrom bzw. Gold



Transparent / Chrom
VOLTA34T01F4



Transparent / Gold
VOLTA34T01F3



Transparent-Gold / Chrom
VOLTA34TGDF4



Transparent-Gold / Gold
VOLTA34TGDF3



VOLTA

- Material: Bleikristall 24%pb
- Gewicht: 7,45 kg
- Maße: Ø 435 x H 175 mm
- Lochbohrung: Ø 45 mm

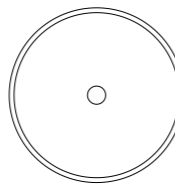

Ø 435

H 175



inkl. Ablaufventil
und Basisring Chrom bzw. Gold



Transparent / Chrom
VOLTAROT01F4



Transparent / Gold
VOLTAROT01F3



Transparent-Gold / Chrom
VOLTAROT01F3



Transparent-Gold / Gold
VOLTAROTGDF3

Hinweis: Bei allen Glasbecken sind kleine Luftpinschlüsse nicht zu vermeiden und gehören zu diesen handgemachten Unikaten ganz selbstverständlich dazu.

Technische Informationen und Montageanleitungen zu den Produkten entnehmen Sie bitte dem entsprechenden Datenblatt auf unserer Homepage myglassdesign.de/produkte.

Aus drucktechnischen Gründen sind bei einzelnen Abbildungen Farbabweichungen nicht auszuschließen.



ASTRO 34

- Material: Bleikristall 24%pb
- Gewicht: 7,45 kg
- Maße: Ø 340 x H 170 mm
- Lochbohrung: Ø 45 mm

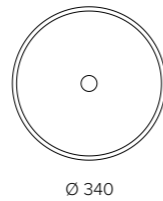

H 170

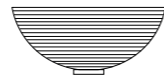

inkl. Ablaufventil
und Basisring Chrom bzw. Gold



Transparent / Chrom
ASTRO34T01F4



Transparent / Gold
ASTRO34T01F3



Transparent-Gold / Chrom
ASTRO34TGDF4



Transparent-Gold / Gold
ASTRO34TGDF3



ASTRO

- Material: Bleikristall 24%pb
- Gewicht: 7,45 kg
- Maße: Ø 435 x H 175 mm
- Lochbohrung: Ø 45 mm

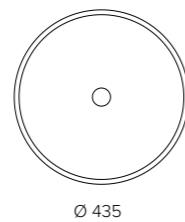

H 175

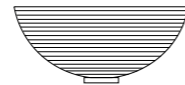

inkl. Ablaufventil
und Basisring Chrom bzw. Gold



Transparent / Chrom
ASTROROT01F4



Transparent / Gold
ASTROROT01F3



Transparent-Gold / Chrom
ASTROROT01F3



Transparent-Gold / Gold
ASTROROTGDF3



SCENIC ASTRO

- Material: Bleikristall 24%pb
- Gewicht: 7,45 kg
- Maße: Ø 440 x H 136 mm
- Lochbohrung: Ø 45 mm

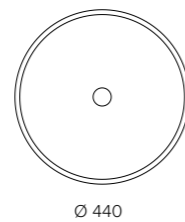

H 136



inkl. Ablaufventil
und Basisring Chrom bzw. Gold



Transparent / Chrom
SCENICASTRT01F4



Transparent / Gold
SCENICASTRT01F3



AQUA

- Material: Bleikristall 24%pb
- Gewicht: 6,7 kg
- Maße: Ø 400 x H 130 mm
- Lochbohrung: Ø 45 mm

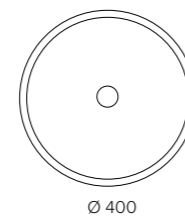

H 130

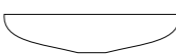

inkl. Ablaufventil
und Basisring Chrom



Transparent
AQUAT01



Schwarz
AQUAT30



PREMIUM

- Material: Bleikristall 24%pb
- Gewicht: 10,2 kg
- Maße: B 530 x T 350 x H 148 mm
- Lochbohrung: Ø 45 mm

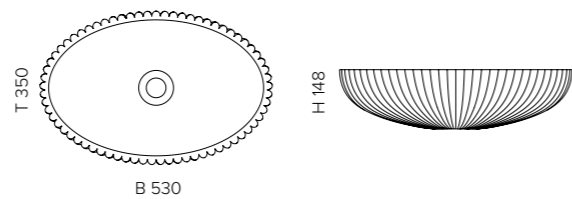

inkl. Ablaufventil
und Basiring Chrom



Transparent
PREMIUMT01F4



Rubinrot
PREMIUMT16F4



Cobaltblau
PREMIUMT18F4



Smaragdgrün
PREMIUMT22F4



Gewittergrau
PREMIUMT45F4



MOON

- Material: Bleikristall 24%pb
- Gewicht: 9,7 kg
- Maße: Ø 345 x H 310 mm
- Lochbohrung: Ø 45 mm

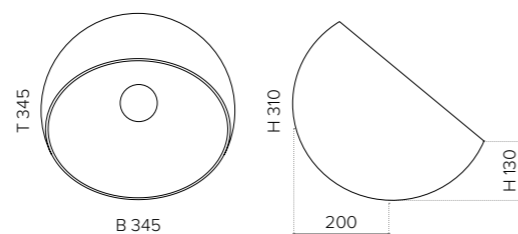

inkl. Ablaufventil
und Basiring Chrom



Transparent
MOONT01F4



ROYAL ABSOLUTE

- Material: Bleikristall 24%pb/
VetroFreddo
- Gewicht: 5,45 kg
- Maße: Ø 365 x H 152 mm
- Lochbohrung: Ø 74 mm

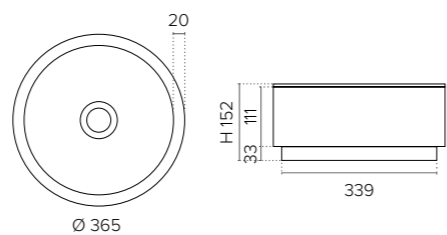

inkl. Ablaufventil
Schwarz matt bzw. Chrom



innen Schwarz matt /
außen Light Gold
ROYALPO30GDHAS



innen Schwarz matt /
außen Dark Inox
ROYALPO30DIAS



innen Schwarz matt /
außen Bronze
ROYALPO30BZAS



innen Weiß glänzend /
außen Light Gold
ROYALWGDHAS



innen Weiß glänzend /
außen Dark Inox
ROYALWDIAS



innen Weiß glänzend /
außen Bronze
ROYALWBZAS



ROYAL ABSOLUTE 40

- Material: Bleikristall 24%pb/
VetroFreddo
- Gewicht: 5,80 kg
- Maße: Ø 400 x H 150 mm
- Lochbohrung: Ø 74 mm

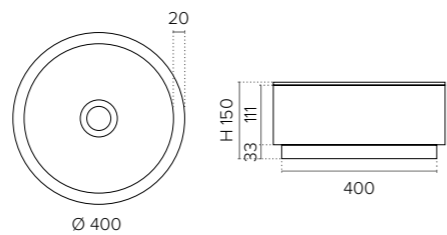

inkl. Ablaufventil
Schwarz matt bzw. Chrom



innen Schwarz matt /
außen Light Gold
ROYAL40PO30GDHA



innen Schwarz matt /
außen Dark Inox
ROYAL40PO30DIAS



innen Schwarz matt /
außen Bronze
ROYAL40PO30BZAS



innen Weiß glänzend /
außen Light Gold
ROYAL40WGDHAS



innen Weiß glänzend /
außen Dark Inox
ROYAL40WDIAS



innen Weiß glänzend /
außen Bronze
ROYAL40WBZAS



METROPOLE KATINO

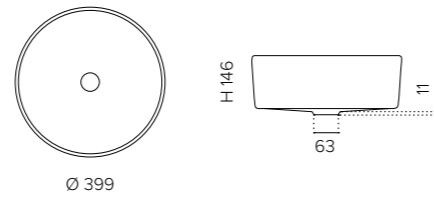

- Material: Kristallglas
- Gewicht: 4,2 kg
- Maße: Ø 399 x H 146 mm
- Lochbohrung: Ø 45 mm

Basiring No.3 und Ablaufventil werden als Zubehör empfohlen



Silber
KATINOMSL



Gold
KATINOMGD



Platin
KATINOMPL



Gold Pink
KATINOMPG



Anthrazit
KATINOMAT



Bronze
KATINOMBZ



Aquamarin
KATINOMTF



Blau
KATINOMBL



Weiß
KATINOMWT



METROPOLE 30

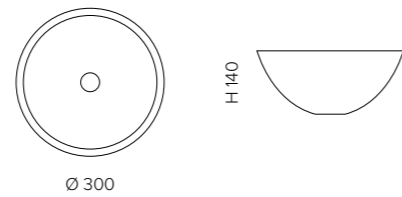

- Material: Kristallglas
- Gewicht: 2,7 kg
- Maße: Ø 300 x H 140 mm
- Lochbohrung: Ø 45 mm

Ablaufventil wird als Zubehör empfohlen



Weiß
METROPOLE30WT



Anthrazit
METROPOLE30AT



Bronze
METROPOLE30BZ



Platin
METROPOLE30PL



METROPOLE 34

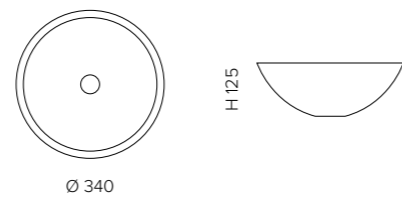

- Material: Kristallglas
- Gewicht: 3,1 kg
- Maße: Ø 340 x H 125 mm
- Lochbohrung: Ø 45 mm

Ablaufventil wird als Zubehör empfohlen



Silber
METROPOLE34SL



Gold
METROPOLE34GD



Platin
METROPOLE34PL



Gold Pink
METROPOLE34PG



Anthrazit
METROPOLE34AT



Bronze
METROPOLE34BZ



Aquamarin
METROPOLE34TF



Blau
METROPOLE34BL



Weiß
METROPOLE34WT

Das passende Zubehör finden Sie ab Seite 408
Hinweis: Bei allen Glasbecken sind kleine Lufteinschlüsse nicht zu vermeiden und gehören zu diesen handgemachten Unikaten ganz selbstverständlich dazu.

Technische Informationen und Montageanleitungen zu den Produkten entnehmen Sie bitte dem entsprechenden Datenblatt auf unserer Homepage myglassdesign.de/produkte.
Aus drucktechnischen Gründen sind bei einzelnen Abbildungen Farbabweichungen nicht auszuschließen.



METROPOLE 40

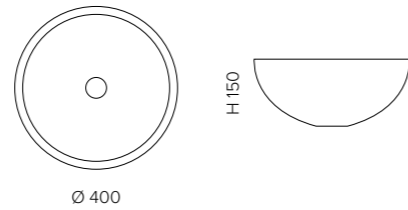

- Material: Kristallglas
- Gewicht: 4,5 kg
- Maße: Ø 400 x H 150 mm
- Lochbohrung: Ø 45 mm

Basisring und Ablaufventil
werden als Zubehör empfohlen



Silber
METROPOLE40SL



Gold
METROPOLE40GD



Platin
METROPOLE40PL



Gold Pink
METROPOLE40PG



Anthrazit
METROPOLE40AT



Bronze
METROPOLE40BZ



Aquamarin
METROPOLE40TF



Blau
METROPOLE40BL



Weiß
METROPOLE40WT



METROPOLE 44

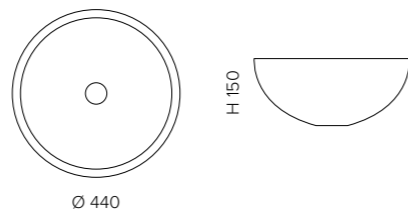

- Material: Kristallglas
- Gewicht: 5,6 kg
- Maße: Ø 440 x H 150 mm
- Lochbohrung: Ø 45 mm

Basisring und Ablaufventil
werden als Zubehör empfohlen



Silber
METROPOLE44SL



Gold
METROPOLE44GD



Platin
METROPOLE44PL



Gold Pink
METROPOLE44PG



Anthrazit
METROPOLE44AT



Bronze
METROPOLE44BZ



Aquamarin
METROPOLE44TF



Blau
METROPOLE44BL



Weiß
METROPOLE44WT



METROPOLE OVAL

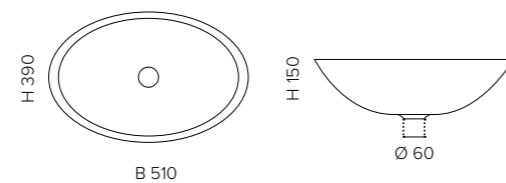

- Material: Kristallglas
- Gewicht: 6,8 kg
- Maße: B 510 x T 390 x H 150 mm
- Lochbohrung: Ø 45 mm

Basisring No.2 und Ablaufventil
werden als Zubehör empfohlen



Silber
FLOUMSL



Gold
FLOUMGD



Platin
FLOUMPL



Gold Pink
FLOUMPG



Anthrazit
FLOUMAT



Bronze
FLOUMBZ



Aquamarin
FLOUMTF



Blau
FLOUMBL



Weiß
FLOUMWT

Das passende Zubehör finden Sie ab Seite 408
Hinweis: Bei allen Glasbecken sind kleine Lufteinschlüsse nicht zu vermeiden und gehören zu diesen handgemachten Unikaten ganz selbstverständlich dazu.

Technische Informationen und Montageanleitungen zu den Produkten entnehmen Sie bitte dem entsprechenden Datenblatt auf unserer Homepage myglassdesign.de/produkte.
Aus drucktechnischen Gründen sind bei einzelnen Abbildungen Farbabweichungen nicht auszuschließen.



LUNA 34

- Material: Kristallglas
- Gewicht: 3,1 kg
- Maße: Ø 340 x H 125 mm
- Lochbohrung: Ø 45 mm

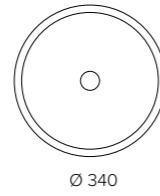

Ablaufventil
wird als Zubehör empfohlen



Grau
LUNA34GR



Sand
LUNA34SN



Weiß
LUNA34WT

Hinweis:
Die weißen Becken sind innen glatt
weiß und weisen produktionsbedingt
keine Schattierungen auf.



LUNA 40

- Material: Kristallglas
- Gewicht: 4,5 kg
- Maße: Ø 400 x H 150 mm
- Lochbohrung: Ø 45 mm

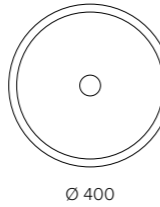

Basisring und Ablaufventil
werden als Zubehör empfohlen



Grau
LUNA40GR



Sand
LUNA40SN



Weiß
LUNA40WT

Hinweis:
Die weißen Becken sind innen glatt
weiß und weisen produktionsbedingt
keine Schattierungen auf.



LUNA 44

- Material: Kristallglas
- Gewicht: 5,6 kg
- Maße: Ø 440 x H 150 mm
- Lochbohrung: Ø 45 mm

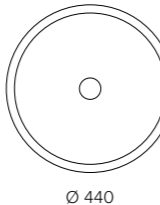

Basisring und Ablaufventil
werden als Zubehör empfohlen



Grau
LUNA44GR



Sand
LUNA44SN



Weiß
LUNA44WT

Hinweis:
Die weißen Becken sind innen glatt
weiß und weisen produktionsbedingt
keine Schattierungen auf.



LUNA 45

- Material: Kristallglas
- Gewicht: 6,6 kg
- Maße: Ø 450 x H 170 mm
- Lochbohrung: Ø 45 mm

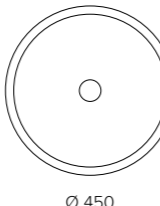

Basisring und Ablaufventil
werden als Zubehör empfohlen



Grau
LUNA45GR



Sand
LUNA45SN



Weiß
LUNA45WT

Hinweis:
Die weißen Becken sind innen glatt
weiß und weisen produktionsbedingt
keine Schattierungen auf.



LUNA OVAL

- Material: Kristallglas
- Gewicht: 7,0 kg
- Maße: B 510 x T 390 x H 150 mm
- Lochbohrung: Ø 45 mm

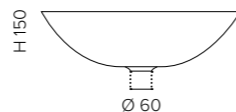
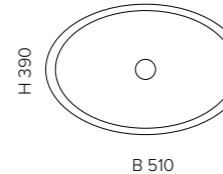

Ablaufventil
wird als Zubehör empfohlen



Grau
LUNAOVGR



Sand
LUNAOVSN



Weiß
LUNAOVWT

Hinweis:
Die weißen Becken sind innen glatt
weiß und weisen produktionsbedingt
keine Schattierungen auf.



LUNA KATINO

- Material: Kristallglas
- Gewicht: 4,2 kg
- Maße: Ø 399 x H 146 mm
- Lochbohrung: Ø 45 mm

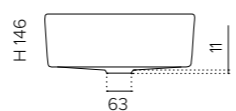
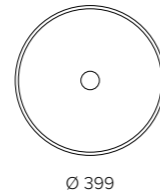

Ablaufventil
wird als Zubehör empfohlen



Grau
KATINOLGR



Sand
KATINOLSN



Weiß
KATINOLWT

Hinweis:
Die weißen Becken sind innen glatt
weiß und weisen produktionsbedingt
keine Schattierungen auf.



GRAFFITI 34

- Material: Kristallglas
- Gewicht: 3,1 kg
- Maße: Ø 340 x H 125 mm
- Lochbohrung: Ø 45 mm

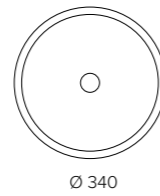

Ablaufventil
wird als Zubehör empfohlen



Rot-Gold-Elfenbein
GRAFFITI34RO



Schwarz-Gold-Elfenbein
GRAFFITI34BG



GRAFFITI 40

- Material: Kristallglas
- Gewicht: 4,3 kg
- Maße: Ø 400 x H 150 mm
- Lochbohrung: Ø 45 mm

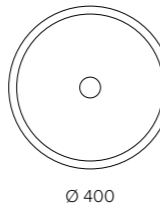

Basisring und Ablaufventil
werden als Zubehör empfohlen



Rot-Gold-Elfenbein
GRAFFITI40RO



Schwarz-Gold-Elfenbein
GRAFFITI40BG



GRAFFITI 44

- Material: Kristallglas
- Gewicht: 5,2 kg
- Maße: Ø 440 x H 150 mm
- Lochbohrung: Ø 45 mm

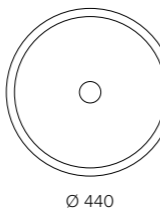

Basisring und Ablaufventil
werden als Zubehör empfohlen



Rot-Gold-Elfenbein
GRAFFITI44RO



Schwarz-Gold-Elfenbein
GRAFFITI44BG



GRAFFITI 2.0 34

- Material: Kristallglas
- Gewicht: 3,1 kg
- Maße: Ø 340 x H 125 mm
- Lochbohrung: Ø 45 mm

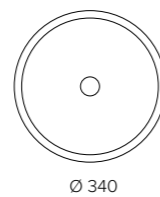

Ablaufventil
wird als Zubehör empfohlen



Weiß-Gold
GRAFFITI34WG



Schwarz-Silber
GRAFFITI34SB



GRAFFITI 2.0 40

- Material: Kristallglas
- Gewicht: 4,3 kg
- Maße: Ø 400 x H 150 mm
- Lochbohrung: Ø 45 mm

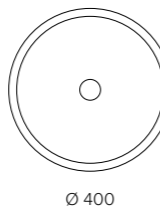

Basisring und Ablaufventil
werden als Zubehör empfohlen



Weiß-Gold
GRAFFITI40WG



Schwarz-Silber
GRAFFITI40SB



GRAFFITI 2.0 44

- Material: Kristallglas
- Gewicht: 5,2 kg
- Maße: Ø 440 x H 150 mm
- Lochbohrung: Ø 45 mm

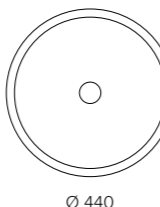

Basisring und Ablaufventil
werden als Zubehör empfohlen



Weiß-Gold
GRAFFITI44WG



Schwarz-Silber
GRAFFITI44SB



KLIO 40

- Material: Kristallglas
- Gewicht: 4,30 kg
- Maße: Ø 400 x H 150 mm
- Lochbohrung: Ø 45 mm

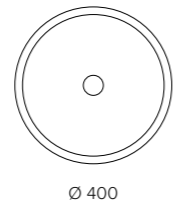

Basisring und Ablaufventil werden als Zubehör empfohlen



Gold matt
KLIO40GDM



Silber matt
KLIO40SLM



Bronze matt
KLIO40BZM



KLIO 44

- Material: Kristallglas
- Gewicht: 5,20 kg
- Maße: Ø 440 x H 150 mm
- Lochbohrung: Ø 45 mm

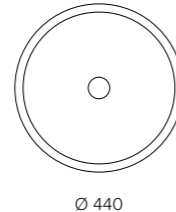

Basisring und Ablaufventil werden als Zubehör empfohlen



Gold matt
KLIO44GDM



Silber matt
KLIO44SLM



Bronze matt
KLIO44BZM



LUSO 34

- Material: Kristallglas
- Gewicht: 3,1 kg
- Maße: Ø 340 x H 125 mm
- Lochbohrung: Ø 45 mm

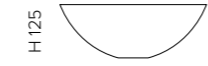
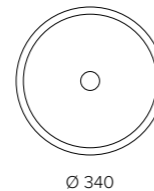

Ablaufventil wird als Zubehör empfohlen



Silber Blattauflage 3D
LUSO34FAAS



Gold Blattauflage 3D
LUSO34FOAS



LUSO 40

- Material: Kristallglas
- Gewicht: 4,3 kg
- Maße: Ø 400 x H 150 mm
- Lochbohrung: Ø 45 mm

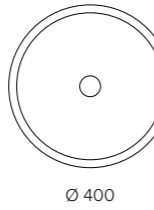

Basisring und Ablaufventil werden als Zubehör empfohlen



Silber Blattauflage 3D
LUSO40FAAS



Gold Blattauflage 3D
LUSO40FOAS



LUSO 44

- Material: Kristallglas
- Gewicht: 5,2 kg
- Maße: Ø 440 x H 150 mm
- Lochbohrung: Ø 45 mm

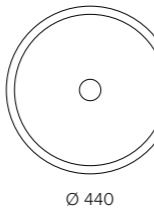

Basisring und Ablaufventil werden als Zubehör empfohlen



Silber Blattauflage 3D
LUSO44FAAS



Gold Blattauflage 3D
LUSO44FOAS



LUSO KATINO

- Material: Kristallglas
- Gewicht: 4,2 kg
- Maße: Ø 399 x H 146 mm
- Lochbohrung: Ø 45 mm

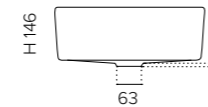
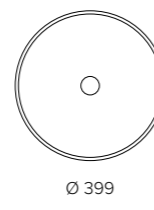

Basisring Nr. 3 und Ablaufventil werden als Zubehör empfohlen



Silber Blattauflage 3D
LUSOK39FAAS



Gold Blattauflage 3D
LUSOK39FOAS



BAMBOO KATINO

- Material: Kristallglas
- Gewicht: 4,2 kg
- Maße: Ø 399 x H 146 mm
- Lochbohrung: Ø 45 mm

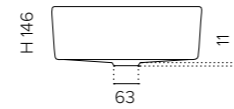
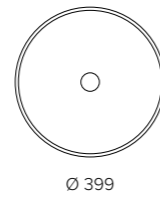

Basisring Nr. 3 und Ablaufventil werden als Zubehör empfohlen



Weiß
BAMBOOK39BO



Schwarz
BAMBOOK39NO



Grau
BAMBOOK39GR



OCEAN 34

- Material: Kristallglas
- Gewicht: 3,1 kg
- Maße: Ø 340 x H 125 mm
- Lochbohrung: Ø 45 mm

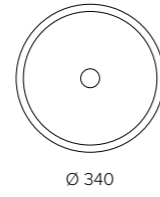

Ablaufventil wird als Zubehör empfohlen



Schwarz-Silber
OCEAN34BS



Schwarz-Gold
OCEAN34BG



Weiß-Gold
OCEAN34WG



Blau-Gold
OCEAN34BLG



OCEAN 40

- Material: Kristallglas
- Gewicht: 4,3 kg
- Maße: Ø 400 x H 150 mm
- Lochbohrung: Ø 45 mm

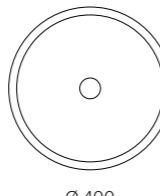

Basisring und Ablaufventil werden als Zubehör empfohlen



Schwarz-Silber
OCEAN40BS



Schwarz-Gold
OCEAN40BG



Weiß-Gold
OCEAN40WG



Blau-Gold
OCEAN40BLG



VENICE 34

- Material: Kristallglas
- Gewicht: 3,1 kg
- Maße: Ø 340 x H 125 mm
- Lochbohrung: Ø 45 mm

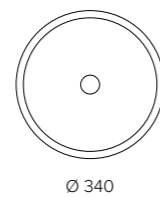

Ablaufventil wird als Zubehör empfohlen



Gold-Silber
VENICE34OA



Silber-Schwarz
VENICE34AN



Braun-Elfenbein
VENICE34MA



VENICE 40

- Material: Kristallglas
- Gewicht: 4,3 kg
- Maße: Ø 400 x H 150 mm
- Lochbohrung: Ø 45 mm

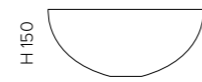
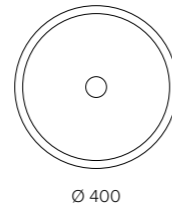

Basisring und Ablaufventil werden als Zubehör empfohlen



Gold-Silber
VENICE40OA



Silber-Schwarz
VENICE40AN



Braun-Elfenbein
VENICE40MA



VENICE 44

- Material: Kristallglas
- Gewicht: 5,2 kg
- Maße: Ø 440 x H 150 mm
- Lochbohrung: Ø 45 mm

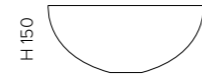
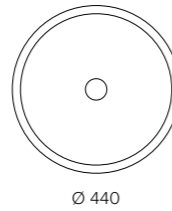

Basisring und Ablaufventil werden als Zubehör empfohlen



Gold-Silber
VENICE44OA



Silber-Schwarz
VENICE44AN



Braun-Elfenbein
VENICE44MA



LINE KATINO

- Material: Kristallglas
- Gewicht: 4,2 kg
- Maße: Ø 399 x H 146 mm
- Lochbohrung: Ø 45 mm

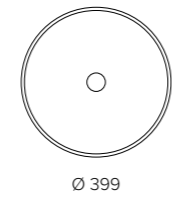

Basisring Nr. 3 und Ablaufventil werden als Zubehör empfohlen



Platin matt
LINEK39PL



Bronze matt
LINEK39BZ



Anthrazit matt
LINEK39AT



XENI

- Material: Kristallglas
- Gewicht: 5,2 kg
- Maße: Ø 440 x H 190 mm
- Lochbohrung: Ø 45 mm

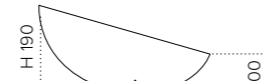
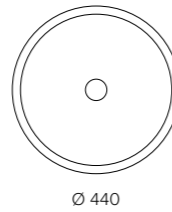

Ablaufventil wird als Zubehör empfohlen



Weiß
XENIT01WHITE



Schwarz
XENIT30BLACK



Champagner
XENIT05CHAMPAG



GALA 40

- Material: Kristallglas
- Gewicht: 4,3 kg
- Maße: Ø 400 x H 150 mm
- Lochbohrung: Ø 45 mm

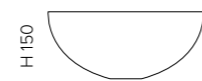
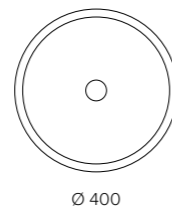

Basisring und Ablaufventil werden als Zubehör empfohlen

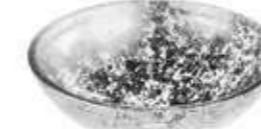

Silber (3D Blattauflege gebrochen)
GALA40FA



Gold (3D Blattauflege gebrochen)
GALA40FO



Kupfer (3D Blattauflege gebrochen)
GALA40FR



GALA 44

- Material: Kristallglas
- Gewicht: 5,2 kg
- Maße: Ø 440 x H 150 mm
- Lochbohrung: Ø 45 mm

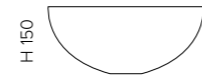
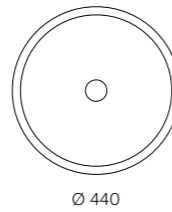

Basisring und Ablaufventil werden als Zubehör empfohlen

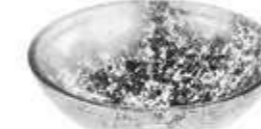

Silber (3D Blattauflege gebrochen)
GALA44FA



Gold (3D Blattauflege gebrochen)
GALA44FO



Kupfer (3D Blattauflege gebrochen)
GALA44FR



SATINATO 44

- Material: Kristallglas
- Gewicht: 6,0 kg
- Maße: Ø 440 x H 150 mm
- Lochbohrung: Ø 45 mm

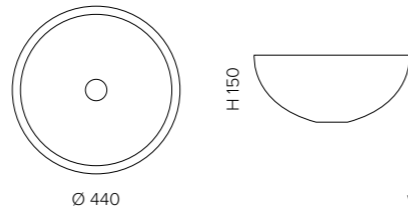

Basisring und Ablaufventil werden als Zubehör empfohlen



Satinier
SATINATO44



ROSE

- (ehem. Serienname GLOBO)
- Material: Kristallglas
 - Gewicht: 3,65 kg
 - Maße: Ø 340 x H 156 mm
 - Lochbohrung: Ø 45 mm
 - passendes Möbelprogramm: BLOOM PLUS

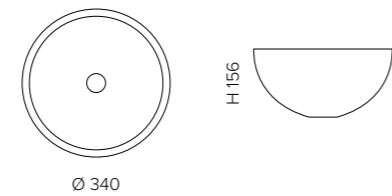

Basisring und Ablaufventil werden als Zubehör empfohlen



Weiß matt
ROSE34BOAS



Schwarz matt
ROSE34NOAS



Orange
ROSE34T38AS



Rubinrot
ROSE34T16AS



Petrol
ROSE34T40AS



Gewittergrau
ROSE34T45AS



Transparent
ROSE34T01



ROSE LUX

- Material: Kristallglas
- Gewicht: 3,65 kg
- Maße: Ø 340 x H 156 mm
- Lochbohrung: Ø 45 mm
- passendes Möbelprogramm: BLOOM PLUS

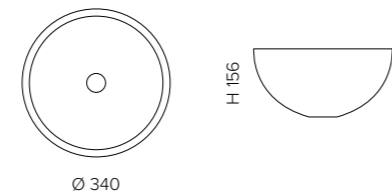

Basisring und Ablaufventil werden als Zubehör empfohlen



Gold
ROSE34LGDAS



Silber
ROSE34LSLAS



Kupfer
ROSE34LCPAS



SOFFIO

- Material: Kristallglas
- Gewicht: 6,0 kg
- Maße: Ø 450 x H 175 mm
- Lochbohrung: Ø 45 mm

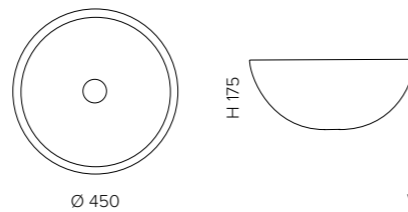

Basisring und Ablaufventil werden als Zubehör empfohlen



Transparent
SOFFIOT01



Silber (3D Blattauflage)
SOFFIOFAAS



Gold (3D Blattauflage)
SOFFIOFOAS



Rubinrot
SOFFIOT16F4AS



SKYLINE SMALL

- Material: Kristallglas
- Beckenboden VetroFreddo
- Gewicht: 5,50 kg
- Maße: B 400 x T 260 x H 120 mm
- Lochbohrung: Ø 45 mm

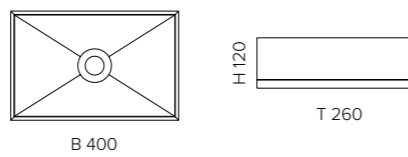

Piletta FreeFlow Ablaufventil wird als Zubehör empfohlen.
Nicht mit absperrbarem Ablaufventil kombinierbar.



Weiß/Transparent
SKYSP001T01



Schwarz/Transparent
SKYSP030T01AS



Schwarz/Fumé
SKYSP030T43AS



SKYLINE MEDIUM

- Material: Kristallglas
- Beckenboden VetroFreddo
- Gewicht: 7,0 kg
- Maße: B 400 x T 350 x H 120 mm
- Lochbohrung: Ø 45 mm

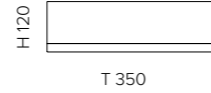
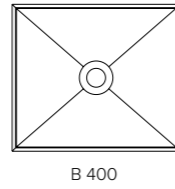

Piletta FreeFlow
Ablaufventil wird als
Zubehör empfohlen.
Nicht mit absperbarem
Ablaufventil kombinierbar.



Weiß/Transparent
SKYMPO01T01



Schwarz/Transparent
SKYMPO30T01AS



Schwarz/Fumé
SKYMPO30T43AS



SKYLINE LARGE

- Material: Kristallglas
- Beckenboden VetroFreddo
- Gewicht: 8,30 kg
- Maße: B 496 x T 346 x H 120 mm
- Lochbohrung: Ø 45 mm

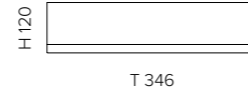
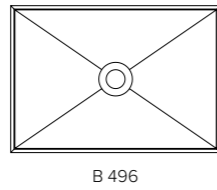

Piletta FreeFlow
Ablaufventil wird als
Zubehör empfohlen.
Nicht mit absperbarem
Ablaufventil kombinierbar.



Weiß/Transparent
SKYLPO01T01



Schwarz/Transparent
SKYLPO30T01AS



Schwarz/Fumé
SKYLPO30T43AS



SKYLINE XL

- Material: Kristallglas
- Beckenboden VetroFreddo
- Gewicht: 10,60 kg
- Maße: B 645 x T 347 x H 120 mm
- Lochbohrung: Ø 45 mm

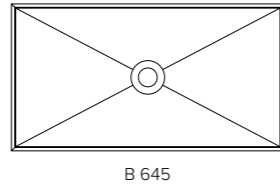

Piletta FreeFlow
Ablaufventil wird als
Zubehör empfohlen.
Nicht mit absperbarem
Ablaufventil kombinierbar.



Weiß/Transparent
SKYXLP001T01



Schwarz/Transparent
SKYXLP030T01AS



Schwarz/Fumé
SKYXLP030T43AS



XTREME SMALL

- Material: Kristallglas
- Beckenboden VetroFreddo schwarz
- Gewicht: 4,60 kg
- Maße: Ø 367 x H 130 mm
- Lochbohrung: Ø 45 mm

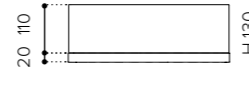
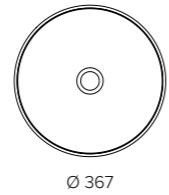

Piletta FreeFlow
Ablaufventil wird als
Zubehör empfohlen.
Nicht mit absperbarem
Ablaufventil kombinierbar.



Schwarz/Transparent
XTREMESPO30T01A



XTREME MEDIUM

- Material: Kristallglas
- Beckenboden VetroFreddo schwarz
- Gewicht: 7,50 kg
- Maße: Ø 367 x H 300 mm
- Lochbohrung: Ø 45 mm

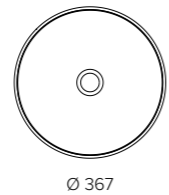

Piletta FreeFlow
Ablaufventil wird als
Zubehör empfohlen.
Nicht mit absperbarem
Ablaufventil kombinierbar.



Schwarz/Transparent
XTREMEMPO30T01A



GLO BALL MURANO

- Material: Murano Glas
- Cover: Vetro Freddo
- Gewicht: 5,20 kg
- Maße: Ø 405 x H 145 mm
- Lochbohrung: Ø 45 mm

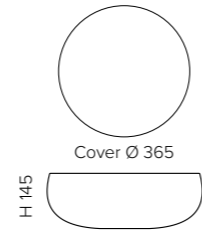
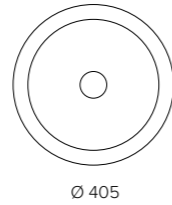

inkl. Ablaufventil
und Basisring Chrom /
Cover Schwarz bzw. Weiß



Amber
(Cover rund schwarz)
GLOBALLMT05AS



Cognac
(Cover rund schwarz)
GLOBALLMT3AS



Fumé
(Cover rund schwarz)
GLOBALLMT43AS



Opal Weiß
(Cover rund weiß)
GLOBALLMT36AS



LAGUNA

- Material: Murano Glas
- Gewicht: 4,70 kg; Gold: 6,3 kg
- Maße: Ø 400 x H 176 mm
- Lochbohrung: Ø 45 mm

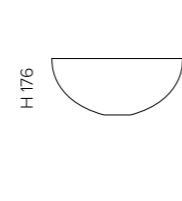
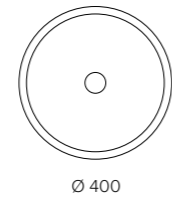

inkl. Ablaufventil
und Basisring Chrom



Gold Transparent
LAGUNAGDF4AS



Braun Transparent
LAGUNAT33F4AS



Rauchglas Transparent
LAGUNAT43F4AS



Blau Transparent
LAGUNAT42F4AS



LAGUNA DEEP

- Material: Murano Glas
- Gewicht: 4,70 kg; Gold: 6,3 kg
- Maße: Ø 400 x H 176 mm
- Lochbohrung: Ø 45 mm

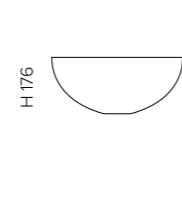
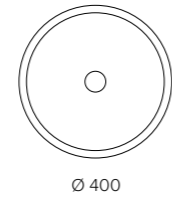

inkl. Ablaufventil
und Basisring Chrom



Deep Smoke
LAGUNADSF3



Deep Blue
LAGUNADBF3



ARTE UNO

- Material: Murano Glas
- Gewicht: 8,40 kg
- Maße: ca. B 650 x T 420 x 210 mm
- Lochbohrung: Ø 45 mm

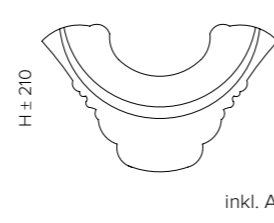
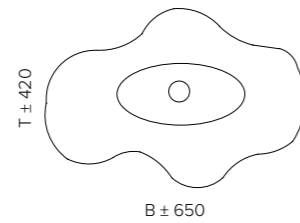

inkl. Ablaufventil Chrom



Transparent / Gold
ARTEUNOF0F4



ARTE DUE

- Material: Murano Glas
- Gewicht: 8,4 kg
- Maße: ca. B 650 x T 420 x 210 mm
- Lochbohrung: Ø 45 mm

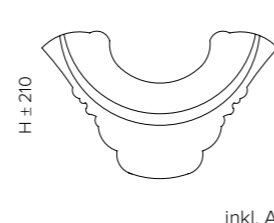
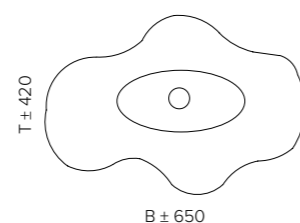

inkl. Ablaufventil Chrom



Schwarz / Gold
ARTEDUENF0F4



ARTE TRE

- Material: Murano Glas
- Gewicht: 12,50 kg
- Maße: ca. B 650 x T 420 x 210 mm
- Lochbohrung: Ø 45 mm

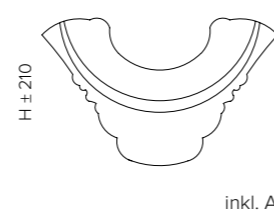
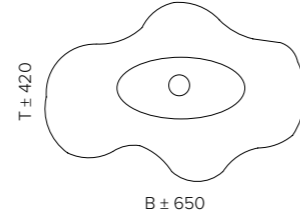

inkl. Ablaufventil Chrom



Transparent / Rot Amber
ARTETRERDF4



ARTE QUATTRO

- Material: Murano Glas
- Gewicht: 12,50 kg
- Maße: ca. B 650 x T 420 x 210 mm
- Lochbohrung: Ø 45 mm

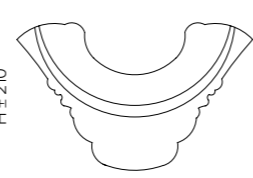
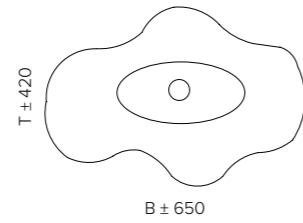

inkl. Ablaufventil Chrom



Transparent / Blau Schwarz
ARTEQUATTROBBF4



ARTE CINQUE

- Material: Murano Glas
- Gewicht: 12,50 kg
- Maße: ca. B 650 x T 420 x 210 mm
- Lochbohrung: Ø 45 mm

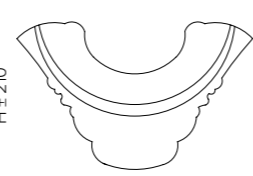
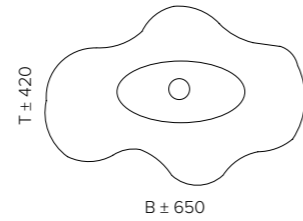

inkl. Ablaufventil Chrom



Transparent / Multicolor
ARTECINQUEMRF4



OTTICO UNO

- Material: Murano Glas
- Gewicht: 6,40 kg
- Maße: ca. Ø 370 x H 196 mm
- Lochbohrung: Ø 45 mm

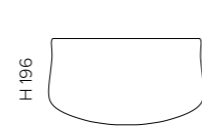
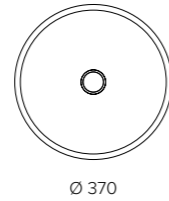

Handgeformtes Unikat –
die Beckenform
kann variieren.
inkl. Ablaufventil
und Basisring Chrom



Grau-Weiß
OTTICOGWF4



OTTICO DUE

- Material: Murano Glas
- Gewicht: 6,40 kg
- Maße: ca. Ø 370 x H 196 mm
- Lochbohrung: Ø 45 mm

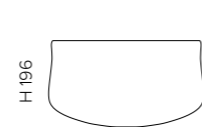
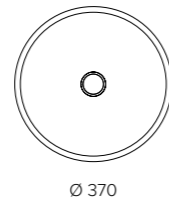

Handgeformtes Unikat –
die Beckenform
kann variieren.
inkl. Ablaufventil
und Basisring Chrom bzw. Gold



Weiß-Gold (Ablaufventil Chrom)
OTTICOWGF4



Weiß-Gold (Ablaufventil Gold)
OTTICOWGF3



KOOL MAX MARBLE

- Material: Marmor
- Gewicht: 9,40 kg
- Maße: B 550 x T 400 x H 150 mm
- Lochbohrung: Ø 45 mm

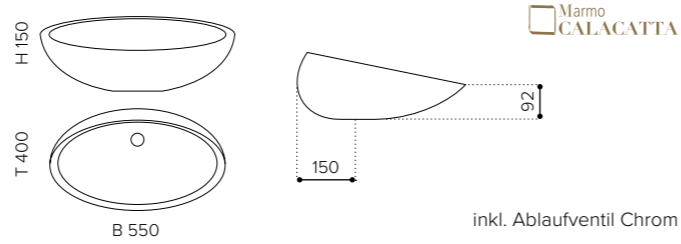

Calacatta
KOOLMAXMARWF4



Marquina
KOOLMAXMARBF4



SKYLINE MARBLE LARGE

- Material: Kristallglas;
- Beckenboden: Marmor
- Gewicht: 11,50 kg
- Maße: B 496 x T 346 x H 120 mm
- Lochbohrung: Ø 45 mm

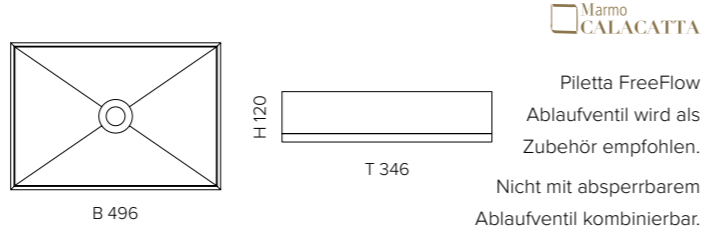

Calacatta / Transparent
SKYLMARWT01



Marquina / Transparent
SKYLMARBT01

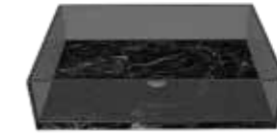

Marquina / Fumé
SKYLMARBT43



SKYLINE MARBLE XL

- Material: Kristallglas;
- Beckenboden: Marmor
- Gewicht: 14,50 kg
- Maße: B 645 x T 347 x H 120 mm
- Lochbohrung: Ø 45 mm

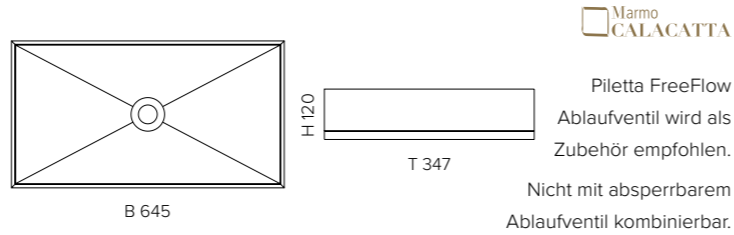

Calacatta / Transparent
SKYXLMARWT01



Marquina / Transparent
SKYXLMARBT01

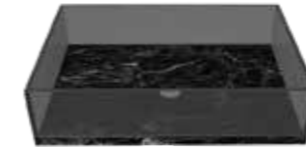

Marquina / Fumé
SKYXLMARBT43



XTREME MARBLE SMALL

- Material: Kristallglas;
- Beckenboden: Marmor
- Gewicht: 6,20 kg
- Maße: Ø 367 x H 130 mm
- Lochbohrung: Ø 45 mm

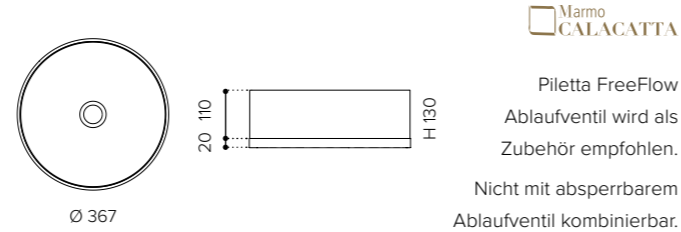

Calacatta / Transparent
XTREMESMARWT01



Marquina / Transparent
XTREMESMARBT01



XTREME MARBLE MEDIUM

- Material: Kristallglas;
- Beckenboden: Marmor
- Gewicht: 6,70 kg
- Maße: Ø 367 x H 300 mm
- Lochbohrung: Ø 45 mm

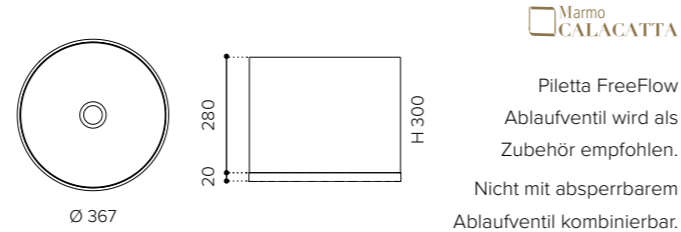

Calacatta / Transparent
XTREMEMMARWT01



Marquina / Transparent
XTREMEMMARBT01



MODE CLASSIC

- Material: handgetöpferte Keramik
- Gewicht: 7,70 kg
- Maße: ca. Ø 420 x H 170 mm
- Lochbohrung: Ø 45 mm

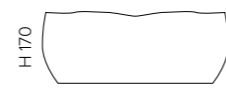
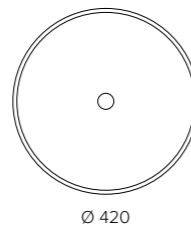

Das Piletta Ablaufventil ist aufgrund der handgetöpften Form zwingend erforderlich



Weiß
MODE40BO



Rustic Weiß
MODE40RWT



Sand
MODE40RSN



Vulcano
MODE40RVL



MODE LUX

- Material: handgetöpferte Keramik
- Gewicht: 7,70 kg
- Maße: ca. Ø 425 x H 162 mm
- Lochbohrung: Ø 45 mm

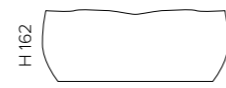
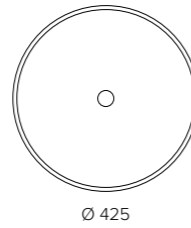

Das Piletta Ablaufventil ist aufgrund der handgetöpften Form zwingend erforderlich



innen Graphit Grau/
außen Bronze
MODE40GMBZAS



innen Graphit Grau/
außen Silber
MODE40GMSLAS



innen Graphit Grau/
außen Light Gold
MODE40GMGDAS



innen Graphit Grau/
außen Dark Inox
MODE40GMDIAS



innen Weiß/
außen Silber
MODE40BOSL



innen Weiß/
außen Light Gold
MODE40BOGD



POLO ART

- Material: handgetöpferte Keramik
- Gewicht: 7,60 kg
- Maße: ca. Ø 425 x H 158 mm
- Lochbohrung: Ø 45 mm

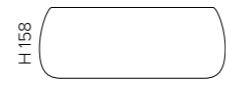
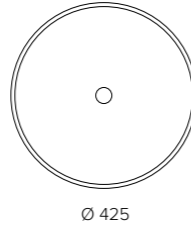

Das Piletta Ablaufventil ist aufgrund der handgetöpften Form zwingend erforderlich



Dark Gold matt
POLO41ART



POLO METAL

- Material: handgetöpferte Keramik
- Gewicht: 7,60 kg
- Maße: ca. Ø 425 x H 158 mm
- Lochbohrung: Ø 45 mm

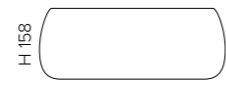
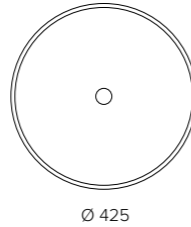

Das Piletta Ablaufventil ist aufgrund der handgetöpften Form zwingend erforderlich



Alt Messing
POLO41METALBR



Corten-Stahl
POLO41METALCRT



POLO TERRA

- Material: handgetöpferte Keramik
- Gewicht: 7,60 kg
- Maße: ca. Ø 425 x H 158 mm
- Lochbohrung: Ø 45 mm

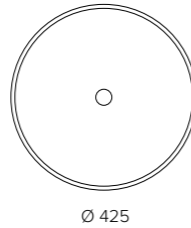

Das Piletta Ablaufventil ist aufgrund der handgetöpften Form zwingend erforderlich



Natur
POLO41TERRAST



Grün
POLO41TERRATF



POLO LUX

- Material: handgetöpferte Keramik
- Gewicht: 7,70 kg
- Maße: ca. Ø 425 x H 158 mm
- Lochbohrung: Ø 45 mm

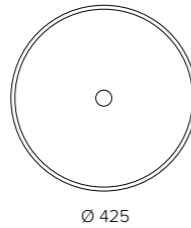

Das Piletta Ablaufventil ist aufgrund der handgetöpften Form zwingend erforderlich



Anthrazit Metallic
POLO41LUXAT



Kupfer Metallic
POLO41LUXCP



Bronze Metallic
POLO41LUXBZ



Silber Metallic
POLO41LUXSL



COLLE

- Material: handgetöpferte Keramik
- Gewicht: 7,60 kg
- Maße: ca. Ø 425 x H 158 mm
- Lochbohrung: Ø 45 mm

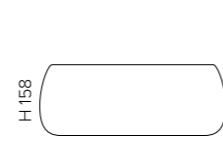
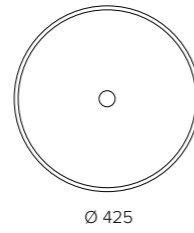

Das Piletta Ablaufventil ist aufgrund der handgetöpferten Form zwingend erforderlich



Weiß (innen matt / außen glänzend)
COLLE41BO



Schwarz (innen matt / außen glänzend)
COLLE41MNO



Kupfer (innen matt / außen glänzend)
COLLE41MCP



Bronze (innen matt / außen glänzend)
COLLE41MBZ



Gold (innen matt / außen glänzend)
COLLE41MGDH



Anthrazit (innen matt / außen glänzend)
COLLE41MAT



VALLE

- Material: handgetöpferte Keramik
- Gewicht: 7,60 kg
- Maße: ca. Ø 425 x H 158 mm
- Lochbohrung: Ø 45 mm

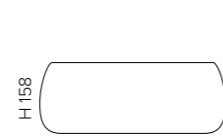
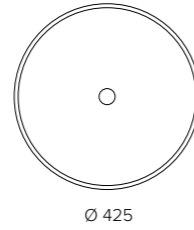

Das Piletta Ablaufventil ist aufgrund der handgetöpferten Form zwingend erforderlich



Weiß matt
VALLE41BO



Schwarz matt
VALLE41MNO



Kupfer matt
VALLE41MCP



Bronze matt
VALLE41MBZ



Gold matt
VALLE41MGDH



Anthrazit matt
VALLE41MAT

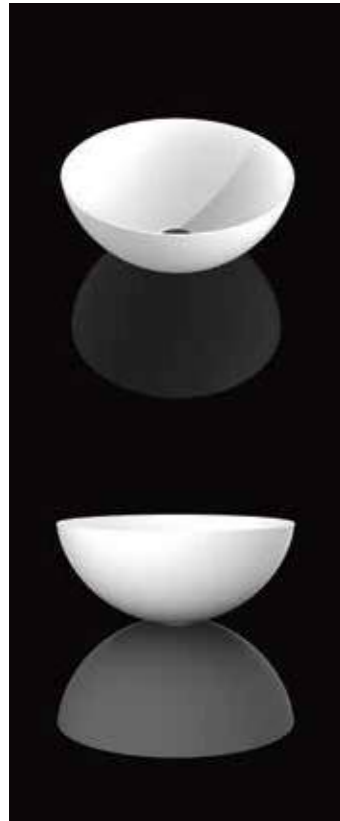

SLIDE 34

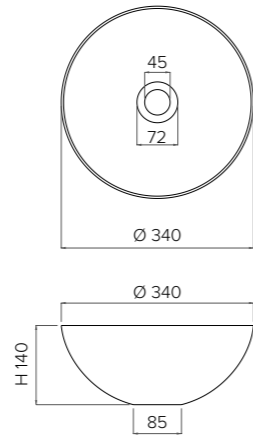

- Material: VetroFreddo
- Gewicht: 2,35 kg
- Maße: Ø 340 x H 140 mm
- Lochbohrung: Ø 45 mm

VetroFreddo®

Basising und Ablaufventil werden als Zubehör empfohlen

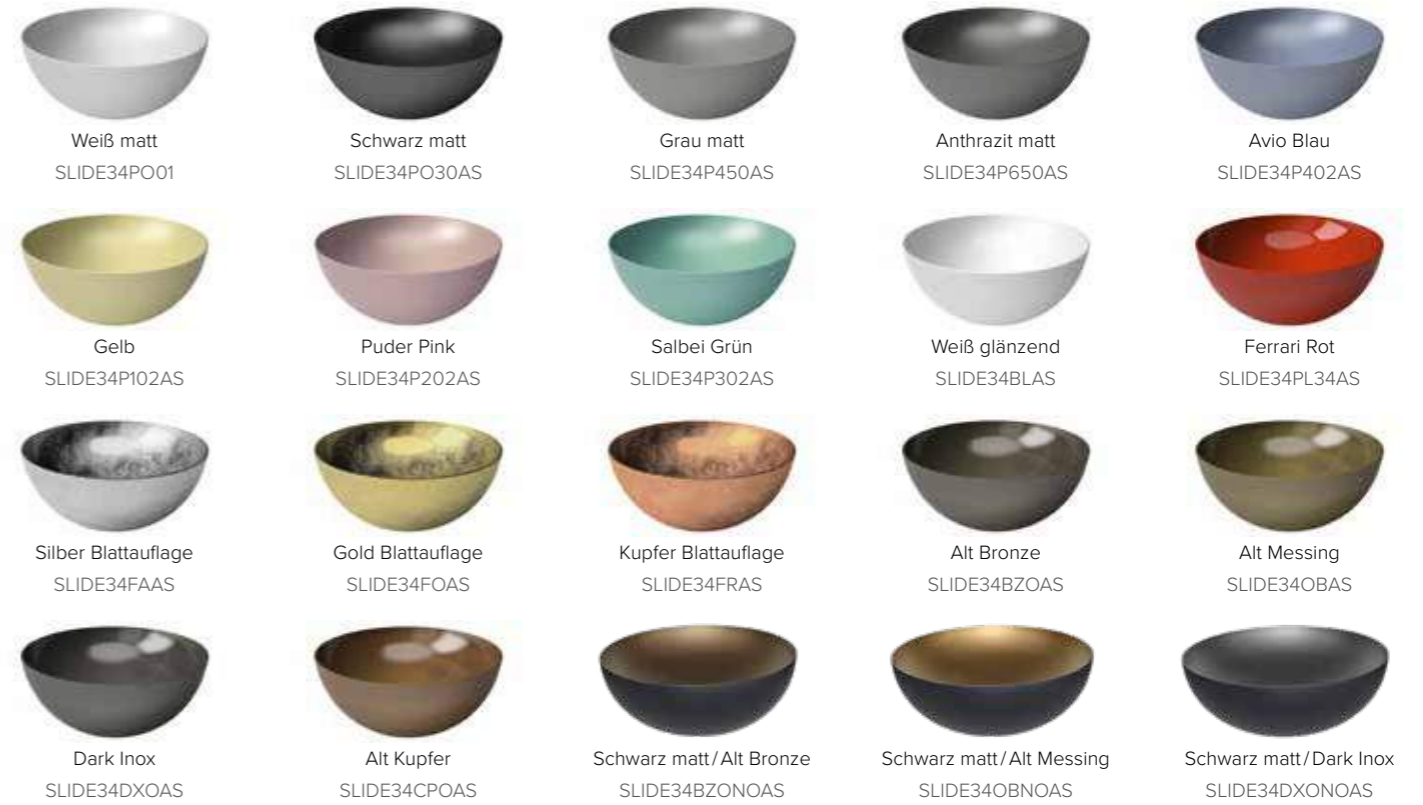

SLIDE 40

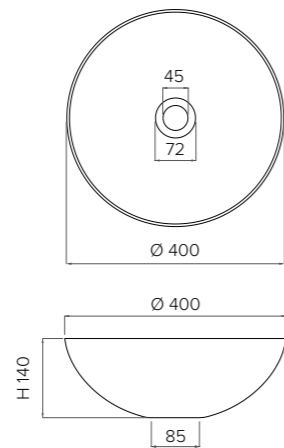

- Material: VetroFreddo
- Gewicht: 2,90 kg
- Maße: Ø 400 x H 140 mm
- Lochbohrung: Ø 45 mm

VetroFreddo®

Basising und Ablaufventil werden als Zubehör empfohlen

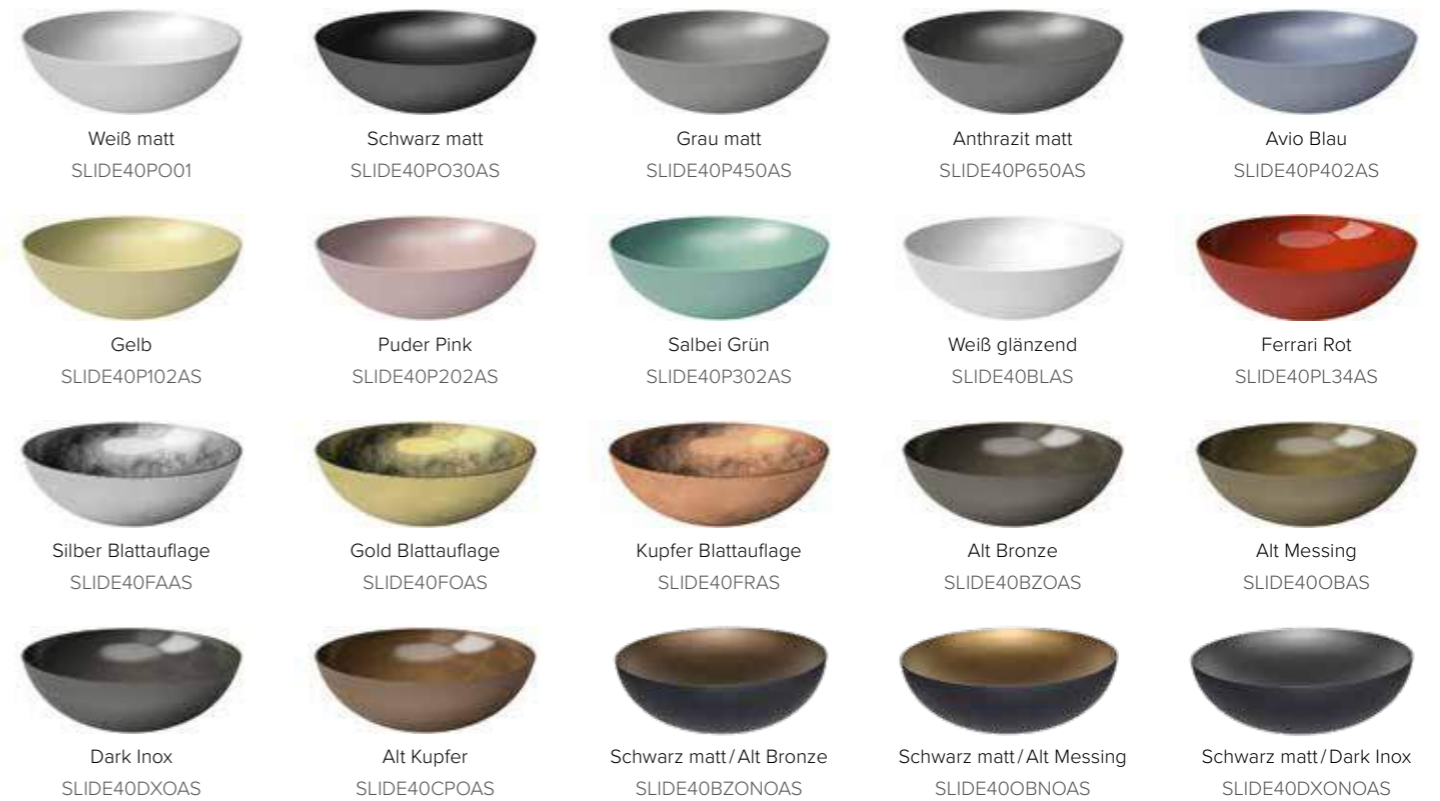

Das passende Zubehör finden Sie ab Seite 408
Hinweis: Bei allen Glasbecken sind kleine Lufteinschlüsse nicht zu vermeiden und gehören zu diesen handgemachten Unikaten ganz selbstverständlich dazu.

Alle VetroFreddo Waschtische mit Ausnahme der Modelle in der Farbe Weiß matt werden serienmäßig mit AntiScratch Oberfläche geliefert.
 Technische Informationen und Montageanleitungen zu den Produkten entnehmen Sie bitte dem entsprechenden Datenblatt auf unserer Homepage myglassdesign.de/produkte. Aus drucktechnischen Gründen sind bei einzelnen Abbildungen Farbabweichungen nicht auszuschließen.



SLIDE 44

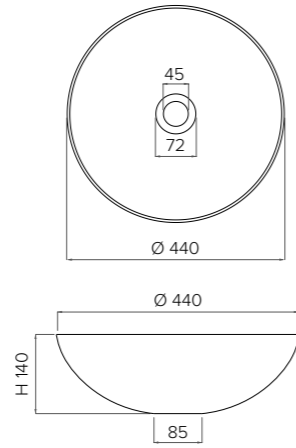

- Material: VetroFreddo
- Gewicht: 4,31 kg
- Maße: Ø 440 x H 140 mm
- Lochbohrung: Ø 45 mm

Basising und Ablaufventil werden als Zubehör empfohlen

VetroFreddo®

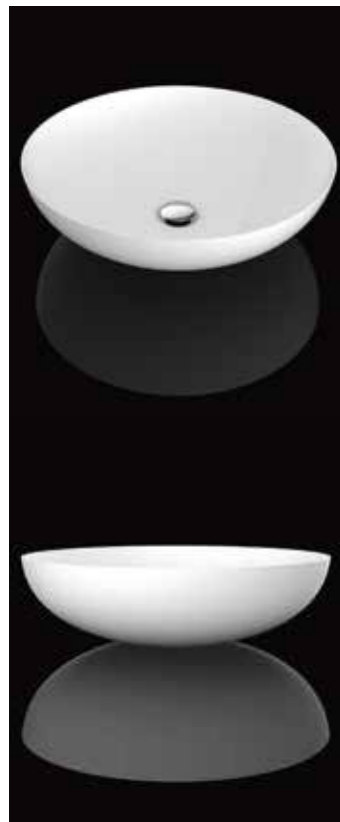
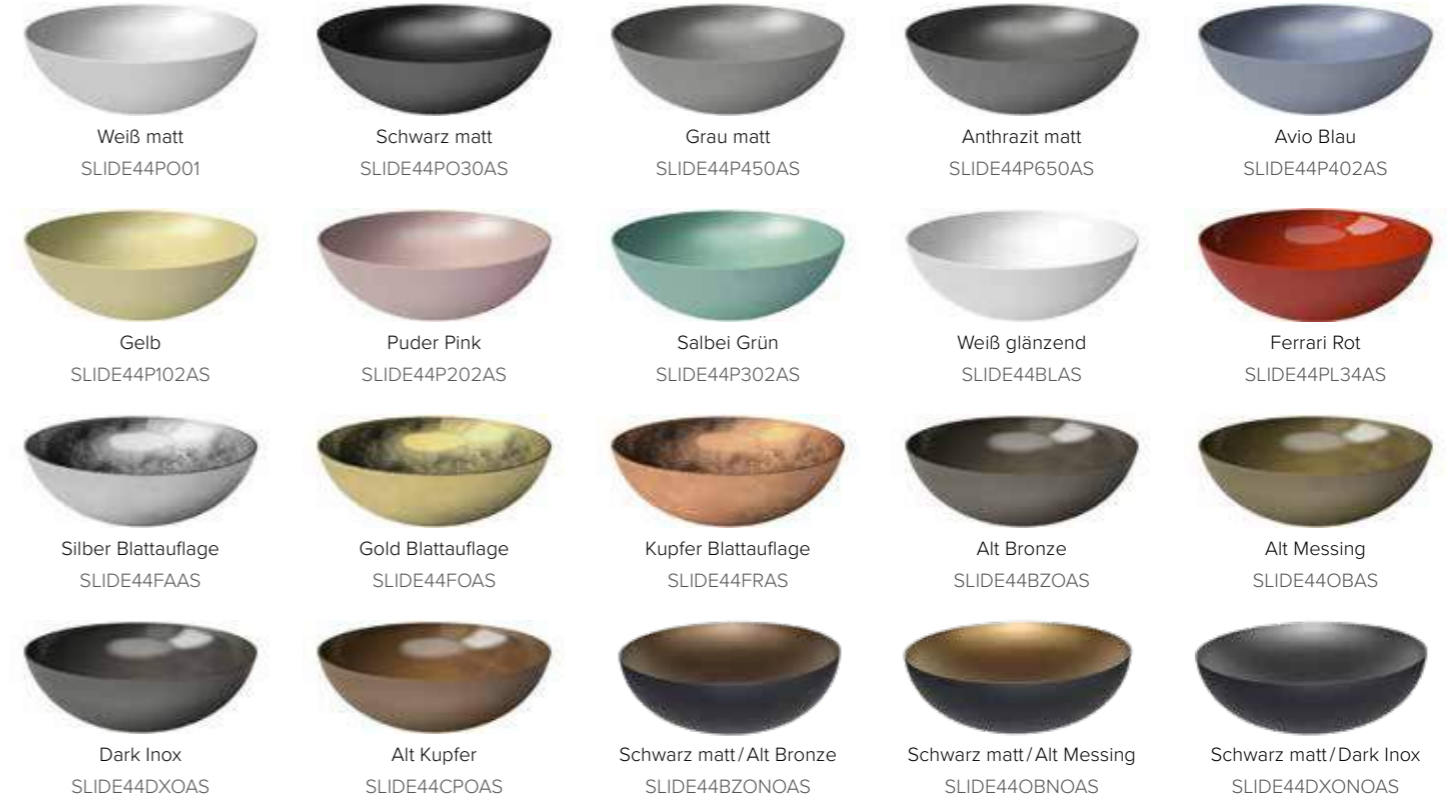

SLIDE 50

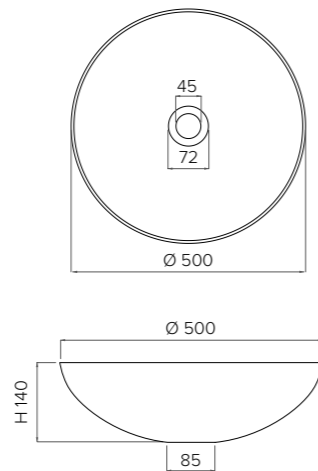

- Material: VetroFreddo
- Gewicht: 5,54 kg
- Maße: Ø 500 x H 140 mm
- Lochbohrung: Ø 45 mm

Basising und Ablaufventil werden als Zubehör empfohlen

VetroFreddo®



Das passende Zubehör finden Sie ab Seite 408
Hinweis: Bei allen Glasbecken sind kleine Lufteinschlüsse nicht zu vermeiden und gehören zu diesen handgemachten Unikaten ganz selbstverständlich dazu.

Alle VetroFreddo Waschtische mit Ausnahme der Modelle in der Farbe Weiß matt werden serienmäßig mit AntiScratch Oberfläche geliefert. Technische Informationen und Montageanleitungen zu den Produkten entnehmen Sie bitte dem entsprechenden Datenblatt auf unserer Homepage myglassdesign.de/produkte. Aus drucktechnischen Gründen sind bei einzelnen Abbildungen Farbabweichungen nicht auszuschließen.



SLIDE OVAL

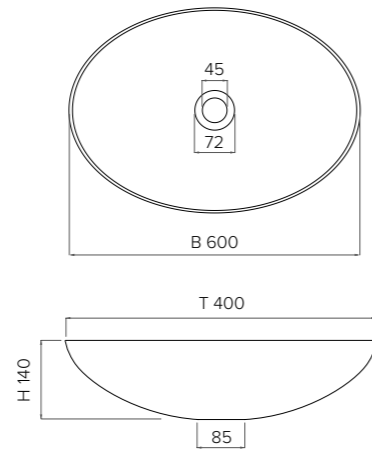

- Material: VetroFreddo
- Gewicht: 5,10 kg
- Maße: B 600 x T 400 x H 140 mm
- Lochbohrung: Ø 45 mm

Basisring und Ablaufventil werden als Zubehör empfohlen

VetroFreddo®

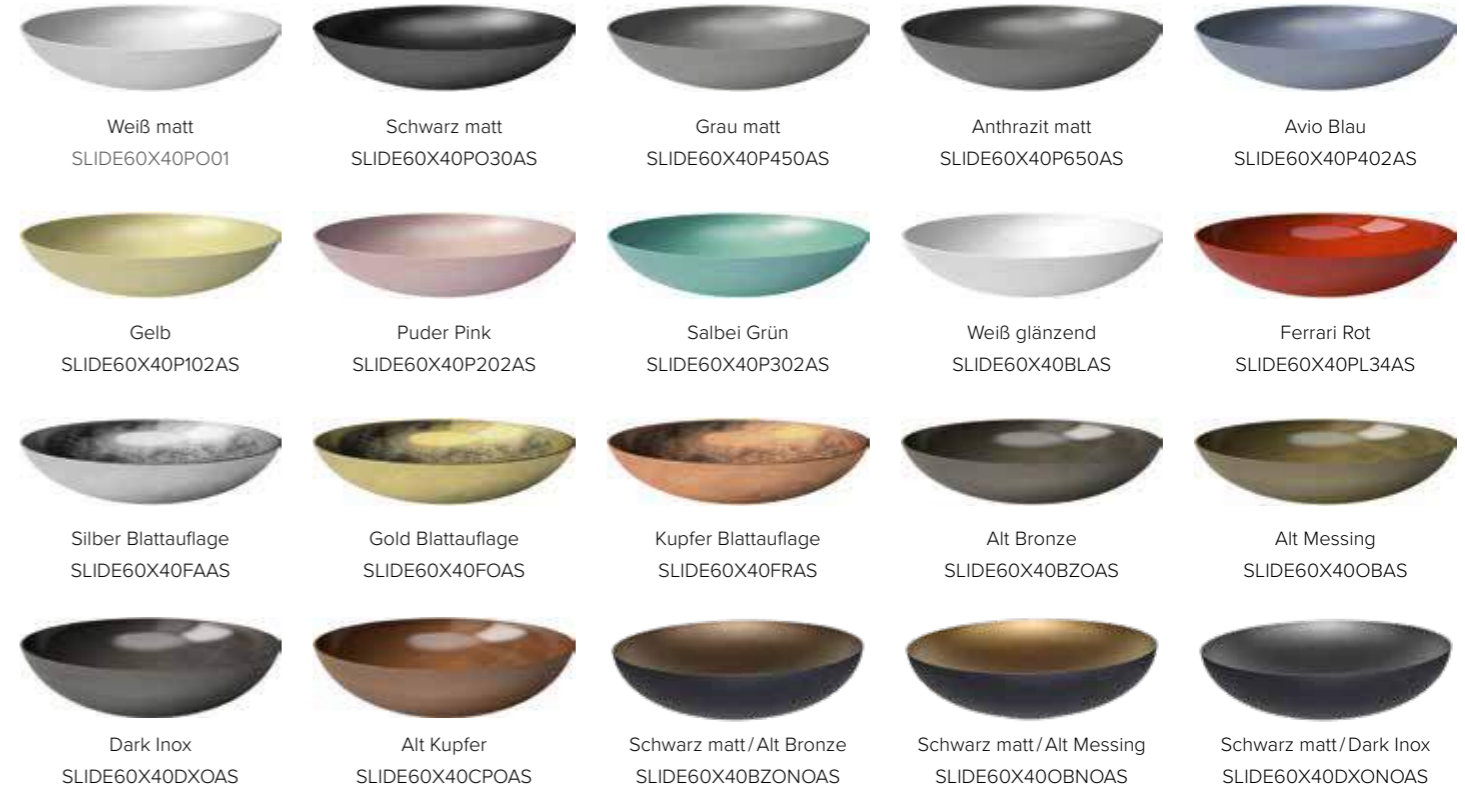

SLIDE RECTANGULAR

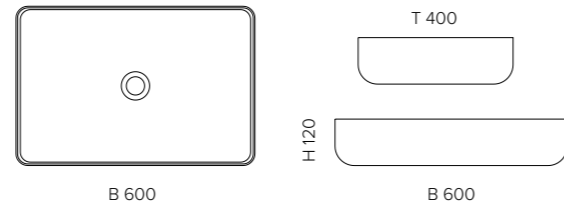

- Material: VetroFreddo
- Gewicht: 10,00 kg
- Maße: B 600 x T 400 x H 120 mm
- Lochbohrung: Ø 45 mm

Ablaufventil wird als Zubehör empfohlen

VetroFreddo®



Das passende Zubehör finden Sie ab Seite 408
Hinweis: Bei allen Glasbecken sind kleine Lufteinschlüsse nicht zu vermeiden und gehören zu diesen handgemachten Unikaten ganz selbstverständlich dazu.

Alle VetroFreddo Waschtische mit Ausnahme der Modelle in der Farbe Weiß matt werden serienmäßig mit AntiScratch Oberfläche geliefert. Technische Informationen und Montageanleitungen zu den Produkten entnehmen Sie bitte dem entsprechenden Datenblatt auf unserer Homepage myglassdesign.de/produkte. Aus drucktechnischen Gründen sind bei einzelnen Abbildungen Farbabweichungen nicht auszuschließen.



COLLINA 35

- Material: VetroFreddo
- Gewicht: 7,0 kg
- Maße: B 350 x H 130 mm
- Lochbohrung: Ø 45 mm

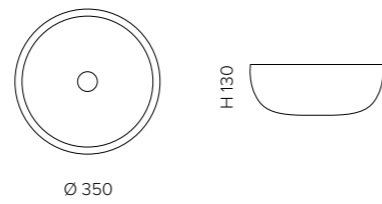

Ablaufventil
wird als Zubehör empfohlen

VetroFreddo®



COLLINA

- Material: VetroFreddo
- Gewicht: 10,80 kg
- Maße: B 450 x H 150 mm
- Lochbohrung: Ø 45 mm

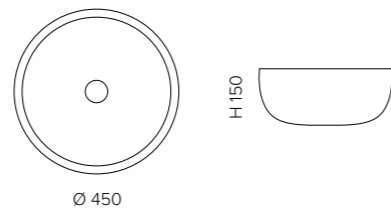

Ablaufventil
wird als Zubehör empfohlen

VetroFreddo®



COLLINA XL

- Material: VetroFreddo
- Gewicht: 10,80 kg
- Maße: B 635 x T 404 x H 150 mm
- Lochbohrung: Ø 45 mm

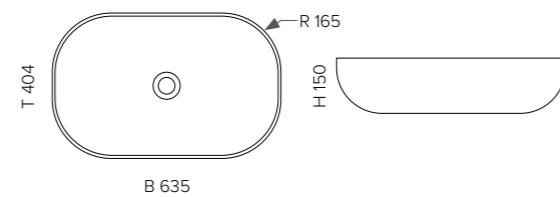

Ablaufventil
wird als Zubehör empfohlen

VetroFreddo®



Das passende Zubehör finden Sie ab Seite 408
Hinweis: Bei allen Glasbecken sind kleine Lufteinschlüsse nicht zu vermeiden und gehören zu diesen handgemachten Unikaten ganz selbstverständlich dazu.

Alle VetroFreddo Waschtische mit Ausnahme der Modelle in der Farbe Weiß matt werden serienmäßig mit AntiScratch Oberfläche geliefert. Technische Informationen und Montageanleitungen zu den Produkten entnehmen Sie bitte dem entsprechenden Datenblatt auf unserer Homepage myglassdesign.de/produkte. Aus drucktechnischen Gründen sind bei einzelnen Abbildungen Farbabweichungen nicht auszuschließen.



COLLINA 35 METROPOLE

- Material: VetroFreddo
- Gewicht: 7,0 kg
- Maße: B 350 x H 130 mm
- Lochbohrung: Ø 45 mm

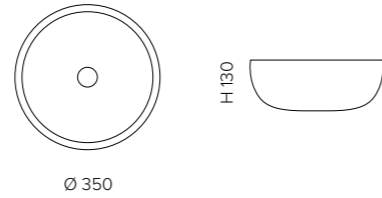

VetroFreddo®

Ablaufventil
wird als Zubehör empfohlen



innen Schwarz matt /
außen Anthrazit
COLL35MATPO30AS



innen Schwarz matt /
außen Bronze
COLL35MBZPO30AS



innen Weiß glänzend /
außen Platin
COLL35MPLWAS



COLLINA METROPOLE

- Material: VetroFreddo
- Gewicht: 10,80 kg
- Maße: B 450 x H 150 mm
- Lochbohrung: Ø 45 mm

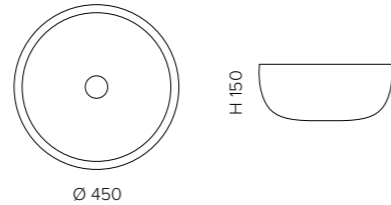

VetroFreddo®

Ablaufventil
wird als Zubehör empfohlen



innen Schwarz matt /
außen Anthrazit
COLLMATPO30AS



innen Schwarz matt /
außen Bronze
COLLMBZPO30AS



innen Weiß glänzend /
außen Platin
COLLMPLWAS



COLLINA XL METROPOLE

- Material: VetroFreddo
- Gewicht: 10,80 kg
- Maße: B 635 x T 404 x H 150 mm
- Lochbohrung: Ø 45 mm

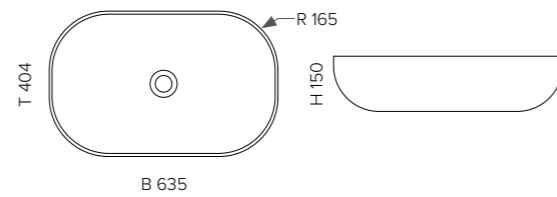

VetroFreddo®

Ablaufventil
wird als Zubehör empfohlen



innen Schwarz matt /
außen Anthrazit
COLLXLMATPO30AS



innen Schwarz matt /
außen Bronze
COLLXLMBZPO30AS



innen Weiß glänzend /
außen Platin
COLLXLPLWAS



KOOL

- Material: VetroFreddo
- Gewicht: 5,50 kg
- Maße: B 435 x T 365 x H 150 mm
- Lochbohrung: Ø 45 mm

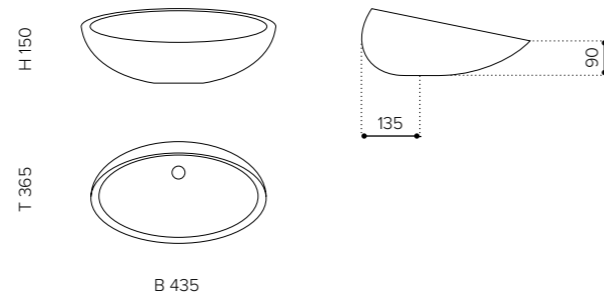

VetroFreddo®

Basisring und Ablaufventil
werden als Zubehör empfohlen



Weiß matt
KOOLPO01



Weiß glänzend
KOOLBLAS



Schwarz matt
KOOLPO30AS



Ferrari Rot
KOOLPL34AS



Silber (Blattauflage 3D)
KOOLFAAS



Gold (Blattauflage 3D)
KOOLFOAS



Kupfer (Blattauflage 3D)
KOOLFRAS



Alt Bronze
KOOLBZOAS



Alt Messing
KOOLBAS



Dark Inox
KOOLDXOAS



Alt Kupfer
KOOLCPOAS

Das passende Zubehör finden Sie ab Seite 408
Hinweis: Bei allen Glasbecken sind kleine Lufteinschlüsse nicht zu vermeiden und gehören zu diesen handgemachten Unikaten ganz selbstverständlich dazu.

Alle VetroFreddo Waschtische mit Ausnahme der Modelle in der Farbe Weiß matt werden serienmäßig mit AntiScratch Oberfläche geliefert. Technische Informationen und Montageanleitungen zu den Produkten entnehmen Sie bitte dem entsprechenden Datenblatt auf unserer Homepage myglassdesign.de/produkte. Aus drucktechnischen Gründen sind bei einzelnen Abbildungen Farbabweichungen nicht auszuschließen.



KOOL MAX

- Material: VetroFreddo
- Gewicht: 6,50 kg
- Maße: B 550 x T 400 x H 150 mm
- Lochbohrung: Ø 45 mm

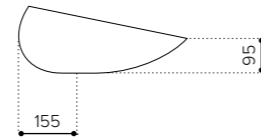
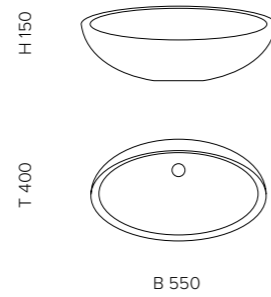

Basisring und Ablaufventil werden als Zubehör empfohlen

VetroFreddo®



KOOL OVERSIZE

- Material: VetroFreddo
- Gewicht: 7,50 kg
- Maße: B 638 x T 480 x H 240 mm
- Lochbohrung: Ø 45 mm

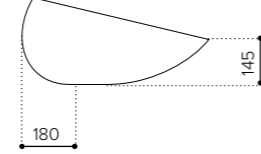
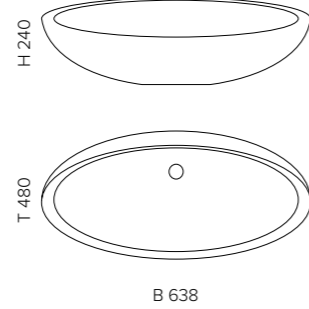

Ablaufventil wird als Zubehör empfohlen

VetroFreddo®



KOOL XL

- Material: VetroFreddo
- Gewicht: 6,70 kg
- Maße: B 645 x T 390 x H 172 mm
- Lochbohrung: Ø 45 mm

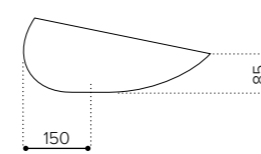
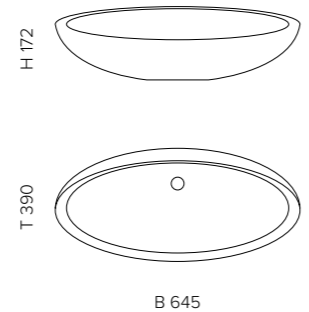

Basisring und Ablaufventil werden als Zubehör empfohlen

VetroFreddo®



Das passende Zubehör finden Sie ab Seite 408
Hinweis: Bei allen Glasbecken sind kleine Lufteinschlüsse nicht zu vermeiden und gehören zu diesen handgemachten Unikaten ganz selbstverständlich dazu.

Alle VetroFreddo Waschtische mit Ausnahme der Modelle in der Farbe Weiß matt werden serienmäßig mit AntiScratch Oberfläche geliefert. Technische Informationen und Montageanleitungen zu den Produkten entnehmen Sie bitte dem entsprechenden Datenblatt auf unserer Homepage myglassdesign.de/produkte. Aus drucktechnischen Gründen sind bei einzelnen Abbildungen Farbabweichungen nicht auszuschließen.



KOOL XL FL HALBEINBAUWASCHTISCH

- Material: VetroFreddo
- Gewicht: 6,50 kg
- Maße: B 635 x T 390 x H 148 mm
- Außenschnittmaß: 560 x 340 mm

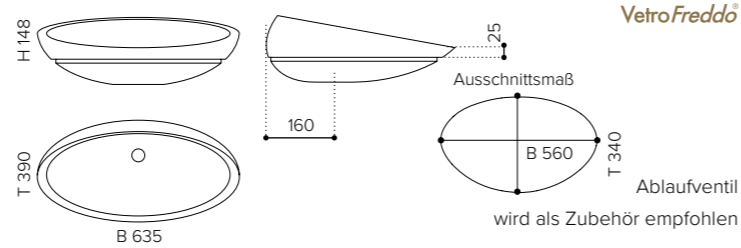

COCOON 34

- Material: VetroFreddo
- Gewicht: 3,20 kg
- Maße: Ø 340 x H 160 mm
- Lochbohrung: Ø 45 mm

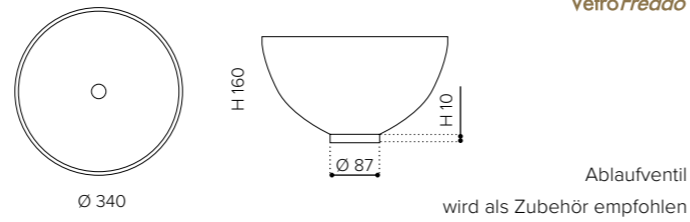

COCOON

- Material: VetroFreddo
- Gewicht: 6,40 kg
- Maße: Ø 492 x H 298 mm
- Lochbohrung: Ø 45 mm

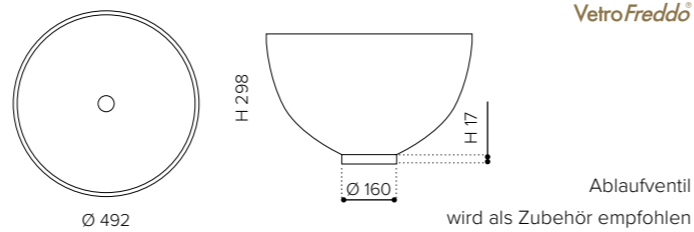

ONE

- Material: VetroFreddo
- Gewicht: 7,50 kg
- Maße: B 340 x T 340 x H 140 mm
- Lochbohrung: Ø 45 mm
- Armaturenlochbohrung beidseitig nutzbar
- passendes Möbelprogramm: ONE PLUS

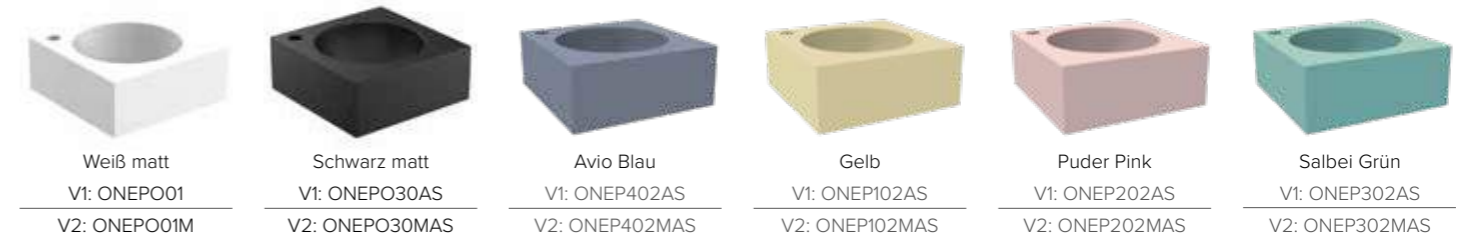
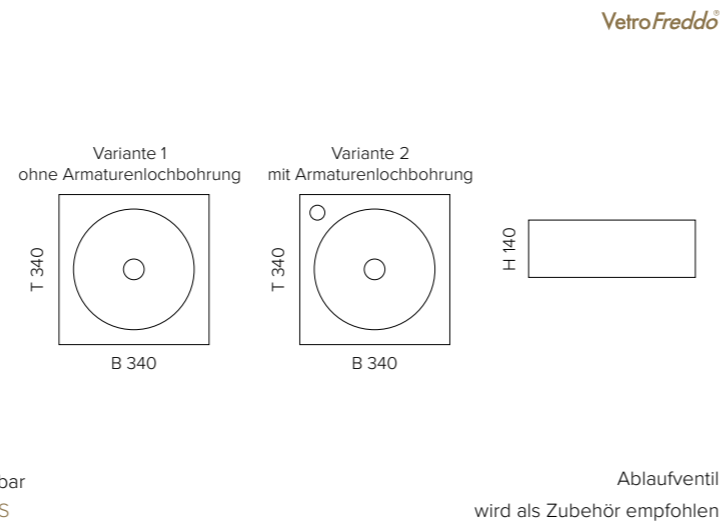

INFINITY OVER

- Material: VetroFreddo
- Gewicht: 6,60 kg
- Maße: B 520 x T 425 x H 180 mm
- Lochbohrung: Ø 45 mm

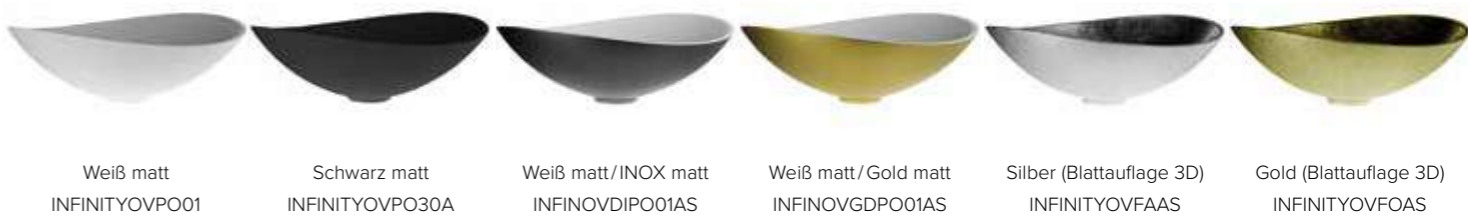
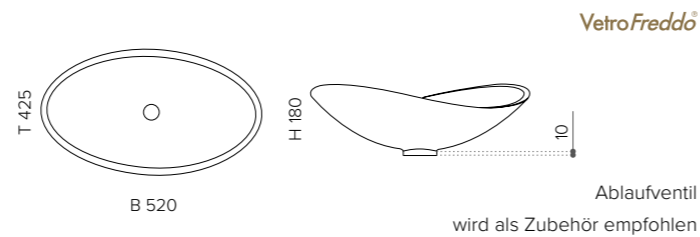

Das passende Zubehör finden Sie ab Seite 408
Hinweis: Bei allen Glasbecken sind kleine Lufteinschlüsse nicht zu vermeiden und gehören zu diesen handgemachten Unikaten ganz selbstverständlich dazu.

Alle VetroFreddo Waschtische mit Ausnahme der Modelle in der Farbe Weiß matt werden serienmäßig mit AntiScratch Oberfläche geliefert. Technische Informationen und Montageanleitungen zu den Produkten entnehmen Sie bitte dem entsprechenden Datenblatt auf unserer Homepage myglassdesign.de/produkte. Aus drucktechnischen Gründen sind bei einzelnen Abbildungen Farbabweichungen nicht auszuschließen.



KOKO.2

VetroFreddo®

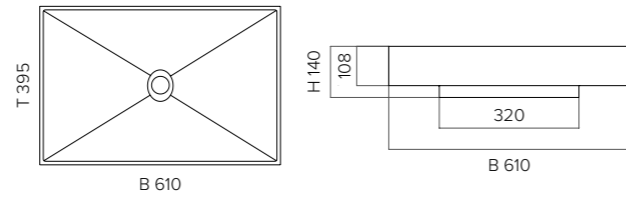

- Material: VetroFreddo
- Gewicht: 12,40 kg
- Maße: B 610 x T 395 x H 140 mm
- Lochbohrung: Ø 45 mm

Ablaufventil
wird als Zubehör empfohlen



Weiß matt
KOKO2PO01



Weiß glänzend
KOKO2BLAS



Schwarz matt
KOKO2PO30AS



Grau matt
KOKO2P450AS



Anthrazit matt
KOKO2P650AS



ALA 80

VetroFreddo®

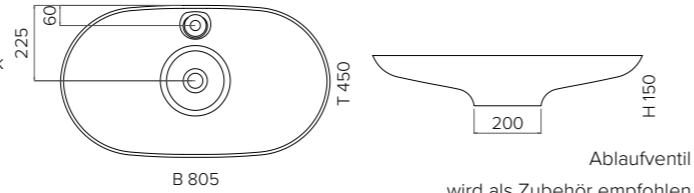

- Waschtisch mit integrierter Armaturenbank
- Material: VetroFreddo
- Gewicht: 7,10 kg
- Maße: B 805 x T 450 x H 150 mm
- Lochbohrung: Ø 45 mm

Ablaufventil
wird als Zubehör empfohlen



Weiß matt
ALA80PO01



Schwarz matt
ALA80PO30AS



innen Weiß matt / aussen
Gold matt
ALA80GDPO01



innen Weiß matt / aussen Dark
Inox matt
ALA80DIPO01



KONKA

VetroFreddo®

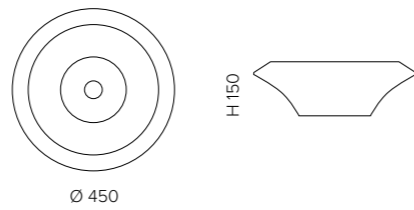

- Material: VetroFreddo
- Gewicht: 12,0 kg
- Maße: Ø 450 x H 150 mm
- Lochbohrung: Ø 45 mm

Ablaufventil
wird als Zubehör empfohlen



Weiß matt
KONKAPO01



Weiß glänzend
KONKABLAS



CIRCUS OVAL

VetroFreddo®

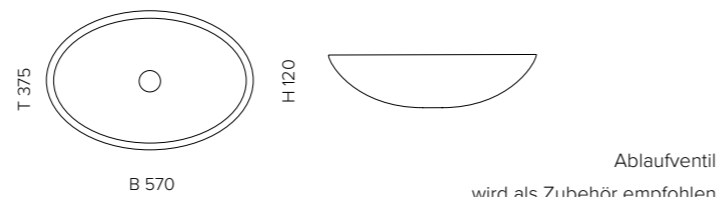

- Material: VetroFreddo
- Gewicht: 6,20 kg
- Maße: B 570 x T 375 x H 120 mm
- Lochbohrung: Ø 45 mm

Ablaufventil
wird als Zubehör empfohlen



Weiß matt
CIRCUSOVPO01



Schwarz matt
CIRCUSOVPO30AS



Silber (Blattauflage 3D)
CIRCUSOVFAAS



Gold (Blattauflage 3D)
CIRCUSOVFOAS



Kupfer (Blattauflage 3D)
CIRCUSOVFRAS



CIRCUS 50

VetroFreddo®

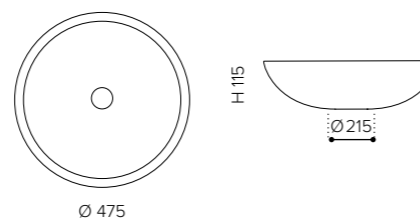

- Material: VetroFreddo
- Gewicht: 9,0 kg
- Maße: Ø 475 x H 115 mm
- Lochbohrung: Ø 45 mm

Ablaufventil
wird als Zubehör empfohlen



Weiß matt
CIRCUS50PO01



Schwarz
CIRCUS50PO30AS



Silber (Blattauflage 3D)
CIRCUS50FAAS



Gold (Blattauflage 3D)
CIRCUS50FOAS



Kupfer (Blattauflage 3D)
CIRCUS50FRAS

Das passende Zubehör finden Sie ab Seite 408
Hinweis: Bei allen Glasbecken sind kleine Lufteinschlüsse nicht zu vermeiden und gehören zu diesen handgemachten Unikaten ganz selbstverständlich dazu.

Alle VetroFreddo Waschtische mit Ausnahme der Modelle in der Farbe Weiß matt werden serienmäßig mit AntiScratch Oberfläche geliefert. Technische Informationen und Montageanleitungen zu den Produkten entnehmen Sie bitte dem entsprechenden Datenblatt auf unserer Homepage myglassdesign.de/produkte. Aus drucktechnischen Gründen sind bei einzelnen Abbildungen Farbabweichungen nicht auszuschließen.



CIRCUS 50 FL HALBEINBAUWASCHTISCH

- Material: VetroFreddo
- Gewicht: 8,80 kg
- Maße: Ø 470 x H 110 mm
- Außenschnittmaß: Ø 382 mm

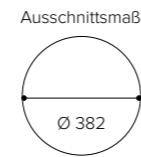
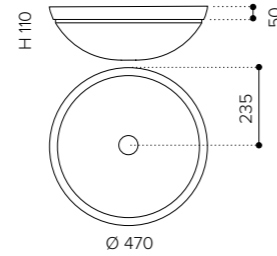

VetroFreddo®

Ablaufventil
wird als Zubehör empfohlen



Weiß
CIRCUS50FLPO01



Schwarz
CIRCUS50FLPO30AS



Silber (Blattauflage 3D)
CIRCUS50FLFAAS



Gold (Blattauflage 3D)
CIRCUS50FLFOAS



CIRCUS 43

- Material: VetroFreddo
- Gewicht: 7,0 kg
- Maße: Ø 420 x H 145 mm
- Lochbohrung: Ø 45 mm

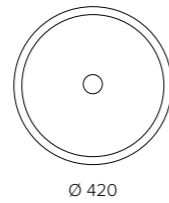

VetroFreddo®

Basisring und Ablaufventil
werden als Zubehör empfohlen



Weiß
CIRCUS43PO01



Schwarz
CIRCUS43PO30AS



Silber (Blattauflage 3D)
CIRCUS43FAAS



Gold (Blattauflage 3D)
CIRCUS43FOAS



Kupfer (Blattauflage 3D)
CIRCUS43FRAS



CIRCUS 43 FL HALBEINBAUWASCHTISCH

- Material: VetroFreddo
- Gewicht: 6,80 kg
- Maße: Ø 415 x H 140 mm
- Außenschnittmaß: Ø 350 mm

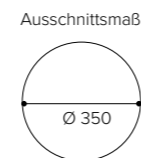
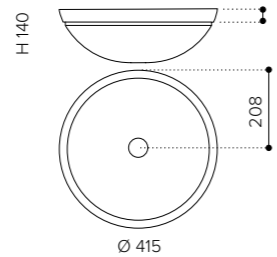

VetroFreddo®

Ablaufventil
wird als Zubehör empfohlen



Weiß
CIRCUS43FLPO01



Schwarz
CIRCUS43FLPO30AS



Silber (Blattauflage 3D)
CIRCUS43FLFAAS



Gold (Blattauflage 3D)
CIRCUS43FLFOAS



RAPOLANO 35 TRAVERTINO

- Material: VetroFreddo
- Gewicht: 5,50 kg
- Maße: Ø 350 x H 130 mm
- Lochbohrung: Ø 45 mm

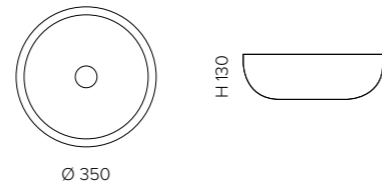

VetroFreddo®
TRAVERTINO

innen und außen
Travertin Struktur

Ablaufventil
wird als Zubehör empfohlen



Travertino Weiß
RAP35B



Travertino Schwarz
RAP35ST30



Travertino Natur
RAP35ST



RAPOLANO 45 TRAVERTINO

- Material: VetroFreddo
- Gewicht: 10,80 kg
- Maße: Ø 450 x H 150 mm
- Lochbohrung: Ø 45 mm

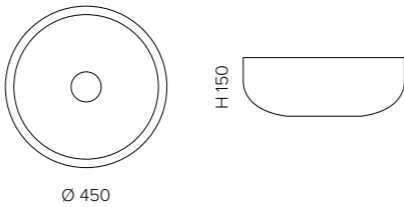

VetroFreddo®
TRAVERTINO

innen und außen
Travertin Struktur

Ablaufventil
wird als Zubehör empfohlen



Travertino Weiß
RAP45B



Travertino Schwarz
RAP45ST30



Travertino Natur
RAP45ST



CIRCUS 43 TRAVERTINO

- Material: VetroFreddo
- Gewicht: 7,0 kg
- Maße: Ø 420 x H 135 mm
- Lochbohrung: Ø 45 mm

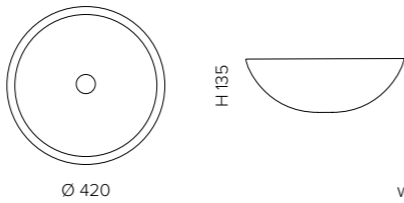

VetroFreddo®
TRAVERTINO

außen Travertino Struktur /
innen glatt

Basisring und Ablaufventil
werden als Zubehör empfohlen



Travertino Weiß
CIRCUS43ST01



Travertino Schwarz
CIRCUS43ST30



OVAL TRAVERTINO

- Material: VetroFreddo
- Gewicht: 5,80 kg
- Maße: B 400 x T 300 x H 150 mm
- Lochbohrung: Ø 45 mm

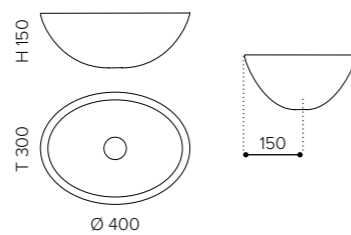

VetroFreddo®
TRAVERTINO

außen Travertino Struktur /
innen glatt

Ablaufventil
wird als Zubehör empfohlen



Travertino Weiß
OVALST01



Travertino Schwarz
OVALST30



RAPOLANO
innen und außen Travertino Struktur



OVAL TRAVERTINO
CIRCUS 43 TRAVERTINO
außen Travertino Struktur – innen glatt



RHO

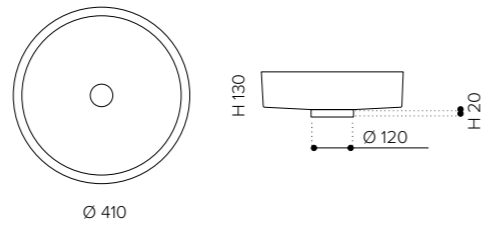

- Material: Pert
- Gewicht: 4,65 kg
- Maße: Ø 410 x H 130 mm
- Lochbohrung: Ø 45 mm

Optional mit RHO Cover kombinierbar
Ablaufventil
wird als Zubehör empfohlen

Pert®
polimero tecnologico



RHO COVER

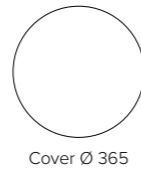

Cover zur Kombination mit
RHO Aufsatzbecken.
Die Cover dienen als Ablaufabdeckung
und werden als Designelement in das
Becken gelegt.

- Material: Pert
- Gewicht: 1,50 kg
- Maße: Ø 365 mm

Pert®
polimero tecnologico





FOUR

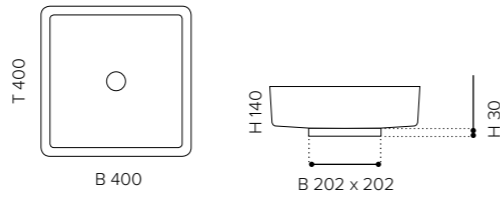

- Material: Pert
- Gewicht: 4,65 kg
- Maße: B 400 x T 400 x H 140 mm
- Lochbohrung: Ø 45 mm

Optional mit FOUR Cover kombinierbar
Ablaufventil
wird als Zubehör empfohlen

Pert®
polimero tecnologico



Schwarz matt
FOURNO.LAVAS



Weiß matt
FOURBO.LAVAS

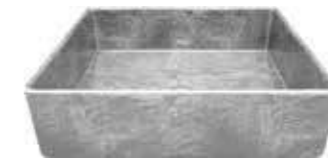

Silber (Blattauflage 3D)
FOURFA.LAVAS



Gold (Blattauflage 3D)
FOURFO.LAVAS



Alt Bronze
FOURBZO.LAVAS



Alt Messing
FOUROB.LAVAS



Dark Inox
FOURDXO.LAVAS



Alt Kupfer
FOURCPO.LAVAS



FOUR COVER

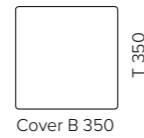

Cover zur Kombination mit
FOUR Aufsatzbecken.
Die Cover dienen als Ablaufabdeckung
und werden als Designelement in das
Becken gelegt.

- Material: Pert
- Gewicht: 1,50 kg
- Maße: B 350 x T 350 mm

Pert®
polimero tecnologico



Schwarz matt
CQNOAS



Weiß matt
CQBOAS



Silber (Blattauflage 3D)
CQFAAS



Gold (Blattauflage 3D)
CQFOAS



Alt Bronze
CQBZOAS



Alt Messing
CQOBAS



Dark Inox
CQDXOAS



Alt Kupfer
CQCPOAS



BLADE

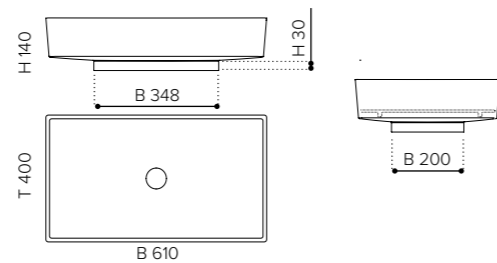

- Material: Pert
- Gewicht: 8,50 kg
- Maße: B 610 x T 400 x H 140 mm
- Lochbohrung: Ø 45 mm

Optional mit BLADE Cover kombinierbar
Ablaufventil
wird als Zubehör empfohlen

Pert®
polimero tecnologico



Schwarz matt
BLADENO.LAVAS



Weiß matt
BLADEBO.LAVAS



Silber (Blattauflage 3D)
BLADEFA.LAVAS



Gold (Blattauflage 3D)
BLADEFO.LAVAS



Alt Bronze
BLADEBZO.LAVAS



Alt Messing
BLADEOB.LAVAS



Dark Inox
BLADEDXO.LAVAS



Alt Kupfer
BLADECPO.LAVAS



BLADE COVER

Cover zur Kombination mit BLADE Aufsatzbecken. Die Cover dienen als Ablaufabdeckung und werden als Designelement in das Becken gelegt.

- Material: Pert
- Gewicht: 1,50 kg
- Maße: B 560 x T 365 mm

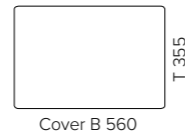

Pert®
polimero tecnologico



Schwarz matt
CRNOAS



Weiß matt
CRBOAS



Silber (Blattauflage 3D)
CRFAAS



Gold (Blattauflage 3D)
CRFOAS



Alt Bronze
CRBZOAS



Alt Messing
CROBAS



Dark Inox
CRDXO



Alt Kupfer
CRCPOAS



INFINITY

- Material: Pert
- Gewicht: 3,30 kg
- Maße: B 650 x T 380 x H 160cm
- Lochbohrung: Ø 45 mm

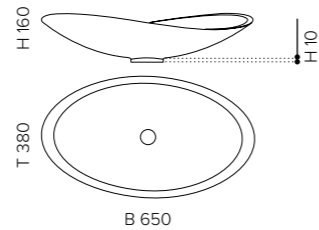

Ablaufventil wird als Zubehör empfohlen

Pert®
polimero tecnologico



Weiß matt
INFINITYBO



Weiß glänzend
INFINITYBLAS



Schwarz matt
INFINITYNOAS



Ferrari Rot
INFINITYPL34AS



INFINITY STARLIGHT

- Material: Pert
- Gewicht: 3,30 kg
- Maße: B 650 x T 380 x H 160cm
- Lochbohrung: Ø 45 mm

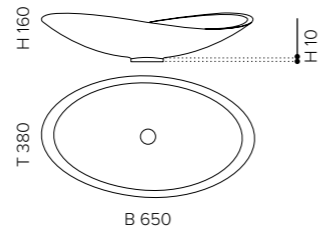

Ablaufventil wird als Zubehör empfohlen

Pert®
polimero tecnologico



Weiß Starlight (Glitzereffekt)
INFINITYLH01AS



Champagner Starlight (Glitzereffekt)
INFINITYLH05AS



Schwarz Starlight (Glitzereffekt)
INFINITYLH30AS



Grau Starlight (Glitzereffekt)
INFINITYLH43AS



OPEN

- Material: Pert
- Gewicht: 3,50 kg
- Maße: B 640 x T 370 x H 140 mm
- Lochbohrung: Ø 45 mm

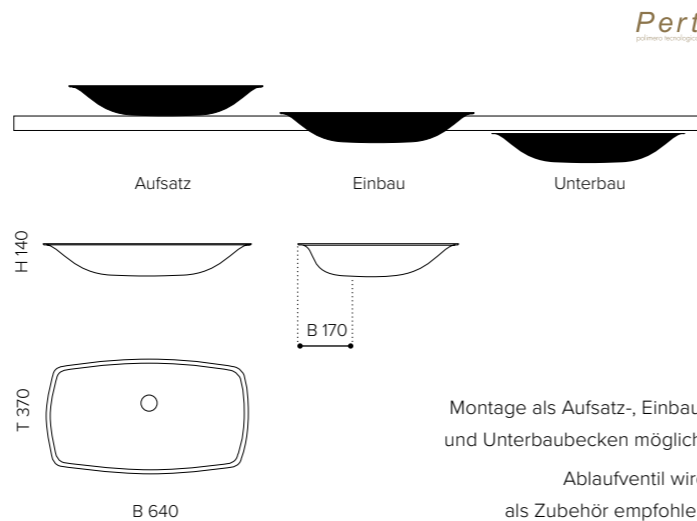

Montage als Aufsatz-, Einbau- und Unterbaubecken möglich. Ablaufventil wird als Zubehör empfohlen

Pert®
polimero tecnologico



Weiß glänzend
OPENBLAS



Schwarz glänzend
OPENNLAS



Silber (Blattauflage 3D)
OPENFAAS



Gold (Blattauflage 3D)
OPENFOAS



FLOWER

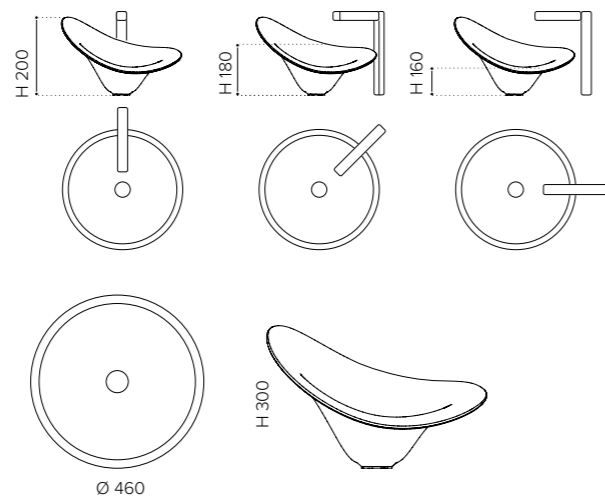

- Material: Pert
- Gewicht: 3,10 kg
- Maße: Ø 460 x H 300 mm
- Lochbohrung: Ø 45 mm

Ablaufventil
wird als Zubehör empfohlen

Pert®
polimero tecnologico

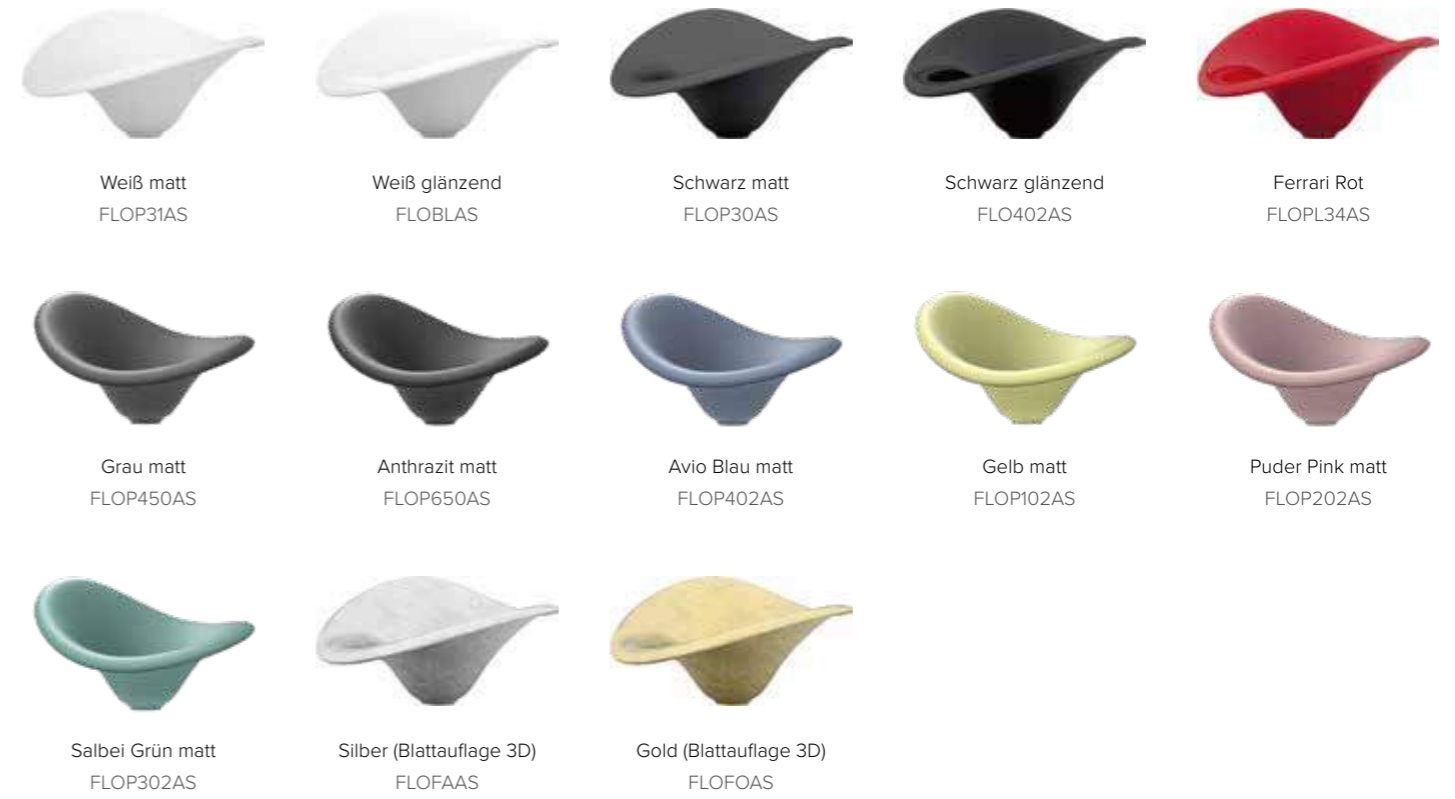



BUBBLE

- Material: Siliconio
- Gewicht: 4,50 kg
- Maße: B 500 x T 360 x H 69 mm
- Lochbohrung: Ø 45 mm

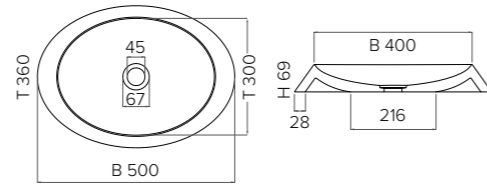

Siliconio®

Ablaufventil
wird als Zubehör empfohlen



Rose
BUBBLES232



Hellblau
BUBBLES277



Gelb
BUBBLES115



Violett
BUBBLES277



BARCHETTA

- Material: Siliconio
- Gewicht: 5,50 kg
- Maße: B 600 x T 300 x H 100 mm
- Lochbohrung: Ø 45 mm

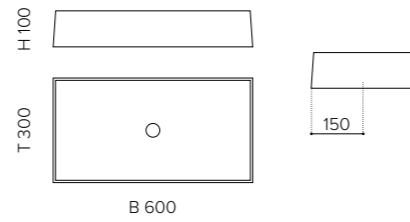

Siliconio®

Ablaufventil
wird als Zubehör empfohlen



Blau
BARCHSL02



Schwarz
BARCHSL30



Grün
BARCHSL32



Rot
BARCHSL34



GUM

- Material: Siliconio
- Gewicht: 3,20 kg
- Maße: B 350 x T 300 x H 100 mm
- Lochbohrung: Ø 45 mm

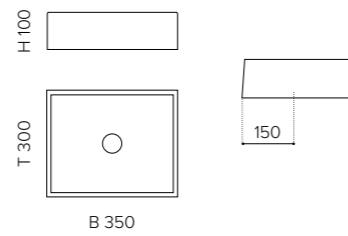

Siliconio®

Ablaufventil
wird als Zubehör empfohlen



Weiß
GUMSL01



Blau
GUMSL02



Gelb
GUMSL05



Orange
GUMSL26



Schwarz
GUMSL30



Rot
GUMSL34



Alice Blau
GUMSL43



Pflaume
GUMSL82



Violett
GUMSL87



FLOWER EVOLUTION

VetroFreddo®

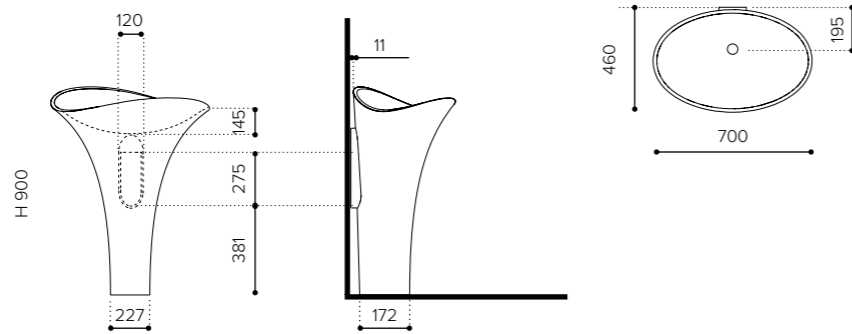

Standwaschtisch mit Wandablauf

- Material: VetroFreddo
- Gewicht: 22,0 kg
- Maße: B 700 x T 460 x H 900 mm

Inkl. Ablaufventil Chrom
 Flexibler Ablauf RACCORDO joint
 zwingend erforderlich.
 Siehe S. 412-413.



Weiß matt FLOEVOPO01 Weiß glänzend FLOEVOBLAS Schwarz matt FLOEVOPO30AS Schwarz glänzend FLOEVONLAS Ferrari Rot FLOEVOPL34AS Silber (Blattauflege 3D) FLOEVOFAAS Gold (Blattauflege 3D) FLOEVOFOAS



Alt Bronze FLOEVOBZOAS Alt Messing FLOEVOOBAS Dark Inox FLOEVODXOAS Alt Kupfer FLOEVOCPOAS innen Weiß matt / außen INOX matt FLOEVODIPO01AS innen Weiß matt / außen Gold matt FLOEVOGDPO01AS



DAME

VetroFreddo®

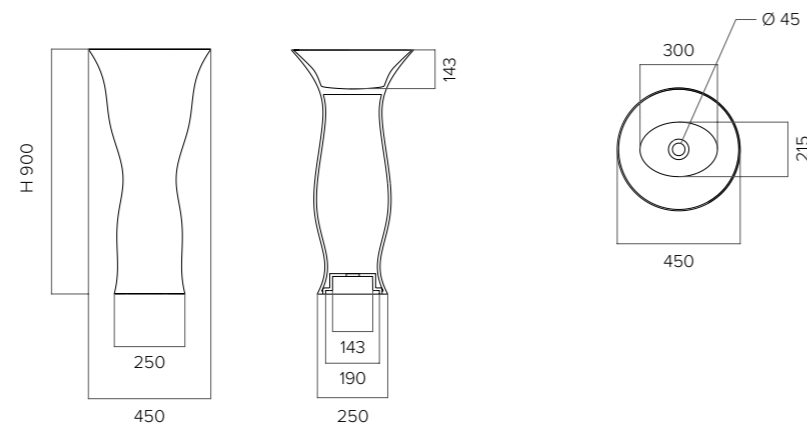

Standwaschtisch mit Bodenablauf

- Material: VetroFreddo
- Gewicht: 16,70 kg
- Maße: Ø 450 x H 900 mm

Inkl. Ablaufventil Chrom
 Bodenablauf:
 Lieferung inkl. Spezialablauf
 Den passenden Spiegel
 finden Sie auf Seite 378



Weiß matt DAMEPO01 Weiß glänzend DAMEBLAS Schwarz matt DAMEPO30AS Grau matt DAMEP450AS Anthrazit matt DAMEP650AS Avio Blau matt DAMEP402AS



Gelb matt DAMEP102AS Puder Pink matt DAMEP202AS Salbeigrün matt DAMEP302AS Ferrari Rot DAMEPL34AS Silber (Blattauflege 3D) DAMEFAAS Gold (Blattauflege 3D) DAMEFOAS

Das passende Zubehör finden Sie ab Seite 408
Hinweis: Bei allen Glasbecken sind kleine Lufteinschlüsse nicht zu vermeiden und gehören zu diesen handgemachten Unikaten ganz selbstverständlich dazu.

Alle Standwaschtische mit Ausnahme der Modelle in der Farbe Weiß matt werden serienmäßig mit AntiScratch Oberfläche geliefert.
 Technische Informationen und Montageanleitungen zu den Produkten entnehmen Sie bitte dem entsprechenden Datenblatt auf unserer Homepage myglassdesign.de/produkte. Aus drucktechnischen Gründen sind bei einzelnen Abbildungen Farbabweichungen nicht auszuschließen.



DAME HAUTE COUTURE

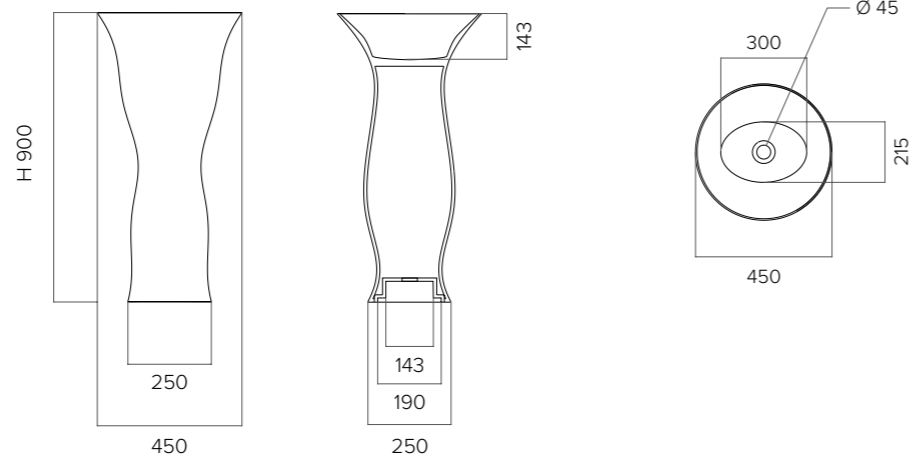

Standwaschtisch mit Bodenablauf

- Material: VetrotFreddo
- Gewicht: 16,70 kg
- Maße: Ø 450 x H 900 mm

VetroFreddo®

Inkl. Ablaufventil Chrom
Bodenablauf:
Lieferung inkl. Spezialablauf
Den passenden Spiegel
finden Sie auf Seite 378



Gelb glänzend
DAMEG102CDAS



Puder glänzend
DAMEG202PPAS



Salbei Grün glänzend
DAMEG302SGAS



Lavendel glänzend
DAMEG303LVAS



Blau-Violett glänzend
DAMEG305VPAS



Hellblau glänzend
DAMEG103ABAS



KHORUS

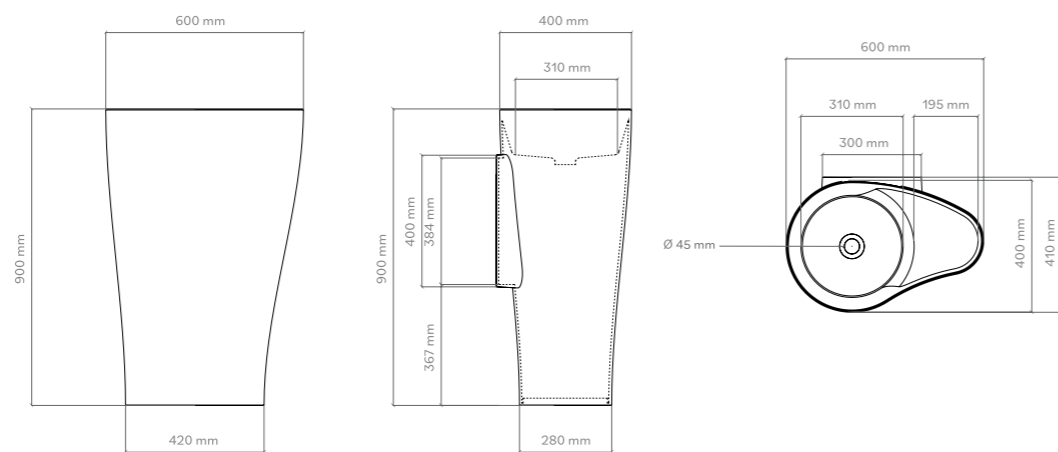

Standwaschtisch mit Bodenablauf

- Material: VetrotFreddo
- Gewicht: 26,45 kg
- Maße: B 600 x T 410 x H 900 mm

Varinate 1: ohne
Armaturenlochbohrung
Varinate 2:
mit Armaturenlochbohrung

VetroFreddo®

inkl. Ablaufventil Chrom
Flexibler Ablauf
RACCORDO joint
zwingend erforderlich.
Siehe S. 412-413.



Weiß matt
V1: KHORUSPO01
V2: KHORUSPO01M



Schwarz matt
V1: KHORUSPO30AS
V2: KHORUSPO30MAS



Weiß glänzend
V1: KHORUSBLAS
V2: KHORUSBLMAS



Schwarz glänzend
V1: KHORUSNLAS
V2: KHORUSNLMAS



Blattsilber / Weiß matt
V1: KHORUSFAPO01AS
V2: KHORUSFAPO01MAS



Gold / Weiß matt
V1: KHORUSFOPO01AS
V2: KHORUSFOPO01MAS



TOMMY METROPOLE MIT WANDABLAUF

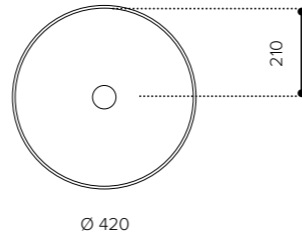
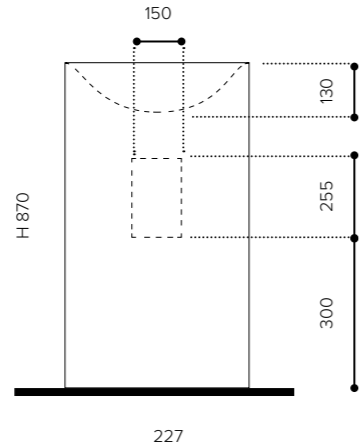

VetroFreddo®

- Material: VetroFreddo
- Gewicht: 28,0 kg
- Maße: Ø 420 x H 870 mm

inkl. Ablaufventil Chrom
bzw. Schwarz matt
Varinate 1 Wandablauf:
Flexibler Ablauf RACCORDO joint
zwingend erforderlich.
Siehe S. 412-413.

Weiß glänzend / Silber V1: TOMMYMSLWAS	Weiß glänzend / Gold V1: TOMMYMGDWAS	Weiß glänzend / Platin V1: TOMMYMPLWAS	Weiß glänzend / Gold Pink V1: TOMMYMPGWAS	Weiß glänzend / Bronze V1: TOMMYMBZWAS	Weiß glänzend / Aquamarin V1: TOMMYMTFWAS
Weiß glänzend / Weiß V1: TOMMYMWTWAS	Schwarz matt / Bronze V1: TOMMYMBZPO30	Schwarz matt / Blau V1: TOMMYMBLPO30AS	Schwarz matt / Anthrazit V1: TOMMYMATPO30AS	Schwarz matt / Silber V1: TOMMYMSLPO30AS	Schwarz matt / Gold V1: TOMMYMGDPO30AS
Schwarz matt / Platin V1: TOMMYMPLPO30AS	Schwarz matt / Gold Pink V1: TOMMYMPGPO30AS	Schwarz matt / Aquamarin V1: TOMMYMTFPO30AS	Schwarz matt / Weiß V1: TOMMYMWTPO30AS		



TOMMY METROPOLE MIT BODENABLAUF

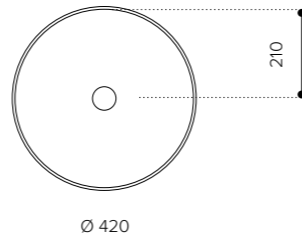
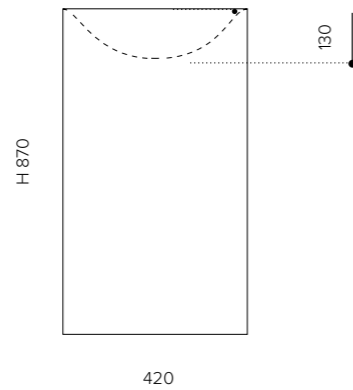

VetroFreddo®

- Material: VetroFreddo
- Gewicht: 28,0 kg
- Maße: Ø 420 x H 870 mm

inkl. Ablaufventil Chrom
bzw. Schwarz matt
Variante 2 Bodenablauf:
Lieferung inkl. Spezialablauf

Weiß glänzend / Silber V2: TOMMYMSLWFWAAS	Weiß glänzend / Gold V2: TOMMYMGDWFWAAS	Weiß glänzend / Platin V2: TOMMYMPLWFWAAS	Weiß glänzend / Gold Pink V2: TOMMYMPGWFWAAS	Weiß glänzend / Bronze V2: TOMMYMBZWFWAAS	Weiß glänzend / Aquamarin V2: TOMMYMTFBWFWAAS
Weiß glänzend / Weiß V2: TOMMYMWTWFWAAS	Schwarz matt / Bronze V2: TOMMYMBZPO30FWAA	Schwarz matt / Blau V2: TOMMYMBLPO30FWAA	Schwarz matt / Anthrazit V2: TOMMYMATPO30FWAA	Schwarz matt / Silber V1: TOMMYMSLPO30AS	Schwarz matt / Gold V1: TOMMYMGDPO30AS
Schwarz matt / Platin V1: TOMMYMPLPO30AS	Schwarz matt / Gold Pink V1: TOMMYMPGPO30AS	Schwarz matt / Aquamarin V1: TOMMYMTFPO30AS	Schwarz matt / Weiß V1: TOMMYMWTPO30AS		

Alle Metalloberflächen sind sowohl mit schwarzem als auch mit weißem Becken kombinierbar.

Das passende Zubehör finden Sie ab Seite 408
Hinweis: Bei allen Glasbecken sind kleine Lufteinschlüsse nicht zu vermeiden und gehören zu diesen handgemachten Unikaten ganz selbstverständlich dazu.

Alle Standwaschtische mit Ausnahme der Modelle in der Farbe Weiß matt werden serienmäßig mit AntiScratch Oberfläche geliefert.
Technische Informationen und Montageanleitungen zu den Produkten entnehmen Sie bitte dem entsprechenden Datenblatt auf unserer Homepage myglassdesign.de/produkte. Aus drucktechnischen Gründen sind bei einzelnen Abbildungen Farbabweichungen nicht auszuschließen.



TOMMY

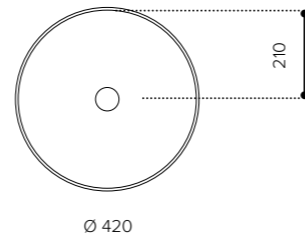
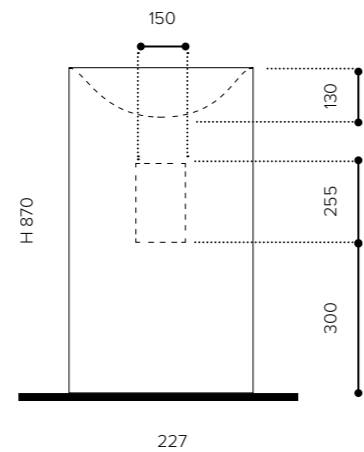

Standwaschtisch mit Wandablauf

- Material: VetrolFreddo
- Gewicht: 28,0 kg
- Maße: Ø 420 x H 870 mm

VetroFreddo®

inkl. Ablaufventil Chrom
Flexibler Ablauf RACCORDO joint
zwingend erforderlich.
Siehe S. 412-413.

Auf Anfrage auch als freistehende
Lösung für Bodenablauf lieferbar.



Weiß matt
TOMMYPO01



Weiß glänzend
TOMMYBLAS



Schwarz matt
TOMMYPO30AS



Schwarz glänzend
TOMMYNLAS



Ferrari Rot
TOMMYPL34AS



Weiß matt / Blattlber
TOMMYFAPO01AS



Weiß matt / Blattgold
TOMMYFOPO01AS



Alt Bronze
TOMMYBZOAS



Alt Messing
TOMMYOBAS



Dark Inox
TOMMYDXOAS



Alt Kupfer
TOMMYCPOAS



Weiß matt / INOX matt
TOMMYDIPO01AS



Weiß matt / Gold matt
TOMMYGDPO01AS



SPAZIO

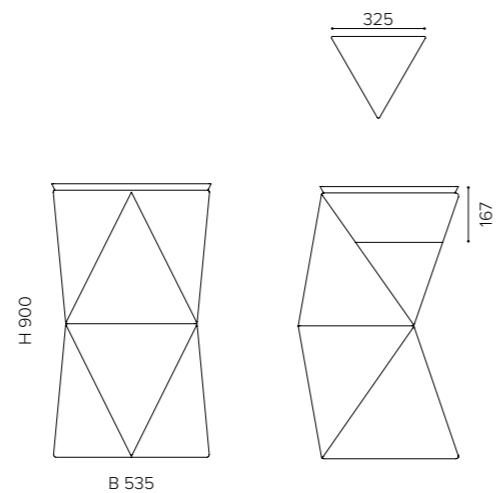

Standwaschtisch mit Bodenablauf

- Material: VetrolFreddo
- Gewicht: 22,50 kg
- Maße: B 535 x T 525 x H 900 mm
- inkl. Cover als Ablaufabdeckung

VetroFreddo®

inkl. Ablaufventil Chrom
und Spezialanschlussgarnitur für
freistehende Waschtische



Weiß matt
SPAZIOP01



Schwarz matt
SPAZIOP030AS



Weiß glänzend
SPAZIOBLAS



Schwarz glänzend
SPAZIONLAS



Ferrari Rot
SPAZIOPL34AS



Silber (Blattauflage 3D)
SPAZIOFAAS



Gold (Blattauflage 3D)
SPAZIOFOAS



innen Weiß matt /
außen INOX matt
SPAZIODIPO01AS



innen Weiß matt /
außen Gold matt
SPAZIOGDPO01AS

Das passende Zubehör finden Sie ab Seite 408
Hinweis: Bei allen Glasbecken sind kleine Lufteinschlüsse nicht zu vermeiden und gehören zu diesen handgemachten Unikaten ganz selbstverständlich dazu.

Alle Standwaschtische mit Ausnahme der Modelle in der Farbe Weiß matt werden serienmäßig mit AntiScratch Oberfläche geliefert.
Technische Informationen und Montageanleitungen zu den Produkten entnehmen Sie bitte dem entsprechenden Datenblatt auf unserer Homepage myglassdesign.de/produkte. Aus drucktechnischen Gründen sind bei einzelnen Abbildungen Farbabweichungen nicht auszuschließen.



LAMBO

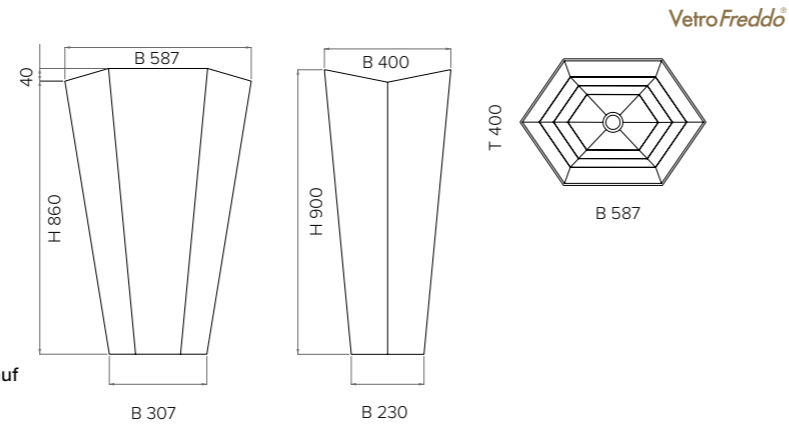

Standwaschtisch mit Bodenablauf

- Material: VetrotFreddo
- Gewicht: 19,80 kg
- Maße: B 587 x T 400 x H 900 mm

inkl. Ablaufventil Schwarz matt und Spezial-Anschlussgarnitur für freistehende Waschtische



Matt Gold /
Becken schwarz
LAMBOGDNOAS



Rot Glänzend /
Becken schwarz
LAMBORDNOAS



Gelb glänzend /
Becken schwarz
LAMBOYLNOAS



Grün glänzend /
Becken schwarz
LAMBOGNNNOAS



AQUARAMA

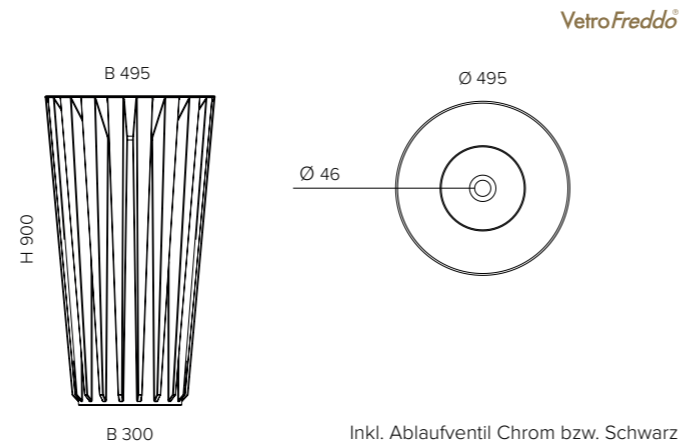

Standwaschtisch mit Bodenablauf

- Material: VetrotFreddo / Kristallglas
- Gewicht: 23,0 kg
- Maße: Ø 495 x H 900 mm

Inkl. Ablaufventil Chrom bzw. Schwarz
Bodenablauf:
Lieferung inkl. Spezialablauf



Weiß matt
AQUARAMAPO01



Schwarz matt
AQUARAMAPO30BLA



Gold matt
AQUARAMAGDAS



Dark Inox matt
AQUARAMADIAS



Bronze matt
AQUARAMABZAS



KALICE

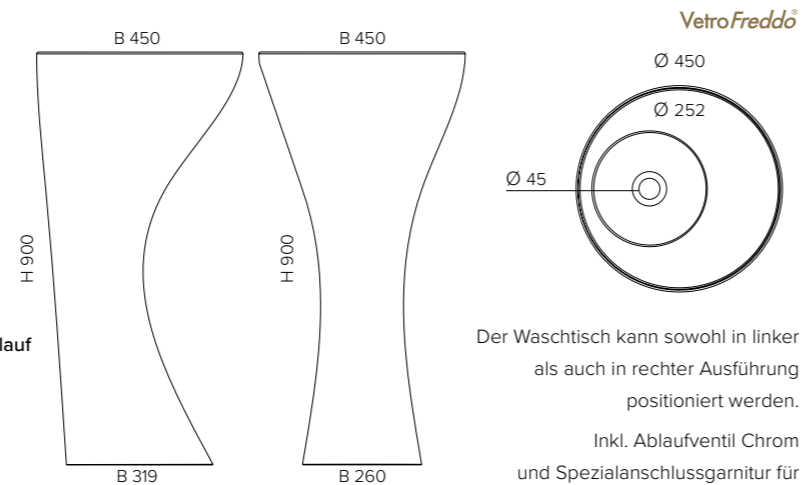

Standwaschtisch mit Bodenablauf

- Material: VetrotFreddo
- Gewicht: 20,0 kg
- Maße: Ø 450 x H 900 mm
- inkl. Cover als Ablaufabdeckung

Der Waschtisch kann sowohl in linker als auch in rechter Ausführung positioniert werden.
Inkl. Ablaufventil Chrom und Spezialanschlussgarnitur für freistehende Waschtische



Weiß matt
KALICEPO01



Schwarz matt
KALICEPO30AS



Schwarz matt / Ablaufventil
Schwarz matt
KALICEPO30BLAS



Weiß glänzend
KALICEBLAS



Schwarz glänzend
KALICENLAS



Silber (Blattauflage 3D) / Weiß
KALICEFAPO01AS



Gold (Blattauflage 3D) / Weiß
KALICEFOPO01AS



Gold (Blattauflage 3D) / Weiß / Gold
KALICEFOPO01F3A

Das passende Zubehör finden Sie ab Seite 408
Hinweis: Bei allen Glasbecken sind kleine Lufteinschlüsse nicht zu vermeiden und gehören zu diesen handgemachten Unikaten ganz selbstverständlich dazu.

Alle Standwaschtische mit Ausnahme der Modelle in der Farbe Weiß matt werden serienmäßig mit AntiScratch Oberfläche geliefert.
Technische Informationen und Montageanleitungen zu den Produkten entnehmen Sie bitte dem entsprechenden Datenblatt auf unserer Homepage myglassdesign.de/produkte. Aus drucktechnischen Gründen sind bei einzelnen Abbildungen Farbabweichungen nicht auszuschließen.



TONDO COMPACT

- Handwaschbecken mit Untergestell
- Waschtisch TONDO Ø 365 mm Weiß, Schwarz, Silber oder Gold
- Material Waschtisch: VetroFreddo
- Metallmöbel mit Armaturenbank, integrierter Ablage und Handtuchhalter
- Maße: B 465 x T 460 x H 890 mm
- Material Möbel: Metall beschichtet in Schwarz matt, Weiß matt oder Alt Messing

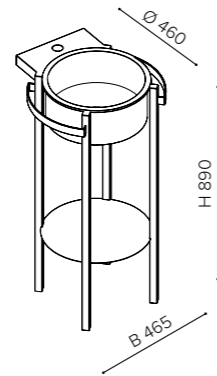

Ablaufventil kurz und Spezial Designsiphon sind als Anschlusszubehör erforderlich



Becken Weiß matt / Gestell Schwarz matt
TONDCOMPNOPO01

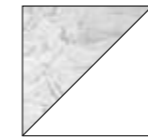

Becken Blattsilber / Gestell Weiß matt
TONDCOMPBOFAAS



Becken Schwarz matt / Gestell Schwarz matt
TONDCOMPNOPO30A



Becken Blattgold / Gestell Weiß matt
TONDCOMPBOFOAS



Becken Blattsilber / Gestell Schwarz matt
TONDCOMPNOFAAS

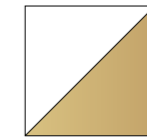

Becken Weiß matt / Gestell Alt Messing
TONDCOMPBOPO01



Becken Blattgold / Gestell Schwarz matt
TONDCOMPNOFOAS



Becken Schwarz matt / Gestell Alt Messing
TONDCOMPBOPO30A

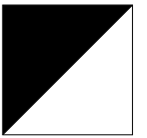

Becken Schwarz matt / Gestell Weiß matt
TONDCOMPBOPO30A

Auf Anfrage ist das Becken Tondo auch in den Trendfarben Avio Blau, Puder Pink, Gelb und Salbei Grün erhältlich



TONDO PLUS

- Handwaschbecken mit Untergestell
- Waschtisch TONDO Ø 365 mm Weiß, Schwarz, Silber oder Gold
- Material Waschtisch: VetroFreddo
- Metallmöbel mit integrierter Ablage und Handtuchhalter
- Maße: B 465 x T 375 x H 890 mm
- Material Möbel: Metall beschichtet in Schwarz matt, Weiß matt oder Alt Messing

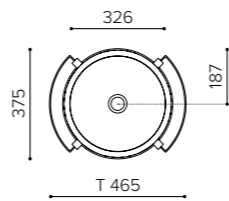
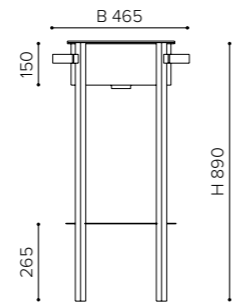

Ablaufventil kurz und Spezial Designsiphon sind als Anschlusszubehör erforderlich

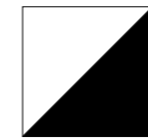

Becken Weiß matt / Gestell Schwarz matt
TONDPLUSNOPO01



Becken Blattsilber / Gestell Weiß matt
TONDPLUSBOFAAS



Becken Schwarz matt / Gestell Schwarz matt
TONDPLUSNOPO30A



Becken Blattgold / Gestell Weiß matt
TONDPLUSBOFOAS



Becken Blattsilber / Gestell Schwarz matt
TONDPLUSNOFAAS

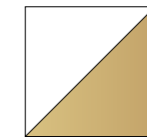

Becken Weiß matt / Gestell Alt Messing
TONDPLUSOBPO01



Becken Blattgold / Gestell Schwarz matt
TONDPLUSNOFOAS



Becken Schwarz matt / Gestell Alt Messing
TONDPLUSOBPO30A

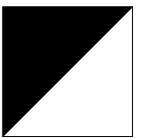

Becken Schwarz matt / Gestell Weiß matt
TONDPLUSBOPO30A

Auf Anfrage ist das Becken Tondo auch in den Trendfarben Avio Blau, Puder Pink, Gelb und Salbei Grün erhältlich



ONE PLUS

- Untergestell für ONE Handwaschbecken
- Metallmöbel mit integrierter Ablage und Handtuchhalter
- Maße: B 340 x T 340 x H 900 mm (Höhe inkl. ONE Waschtisch)
- Material Möbel: Metall beschichtet in Schwarz matt, Weiß matt oder Alt Messing

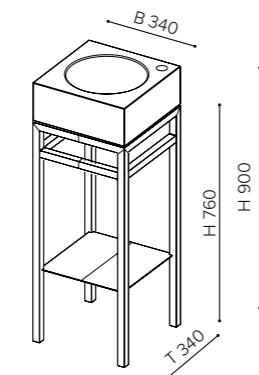

Ablaufventil kurz und Spezial Designsiphon sind als Anschlusszubehör erforderlich

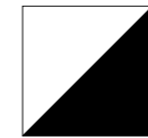

Becken Weiß matt / Gestell Schwarz matt
V1: ONEPLBOPO30AS
V2: ONEPLBOPO30MAS



Becken Schwarz matt / Gestell Weiß matt
V1: ONEPLNOPO01
V2: ONEPLNOPO01M



Becken Schwarz matt / Gestell Schwarz matt
V1: ONEPLNOPO30AS
V2: ONEPLNOPO30MAS

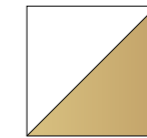

Becken Weiß matt / Gestell Alt Messing
V1: ONEPLOBPO01
V2: ONEPLOBPO01M



Becken Schwarz matt / Gestell Alt Messing
V1: ONEPLOBPO30AS
V2: ONEPLOBPO30MAS

Die Kombination mit anderen Beckenfarben ist auf Anfrage möglich.



BLOOM PLUS

- Untergestell für Aufsatzbecken
- Kombinierbar mit Aufsatzbecken mit einem Durchmesser von 34 cm
- Empfohlenes Modell: ROSE s. Seite 319
- Metallmöbel mit integrierter Ablage und Handtuchhaltern
- Maße: B 530 x T 415 x H 760 mm (Höhe ohne Aufsatzbecken)

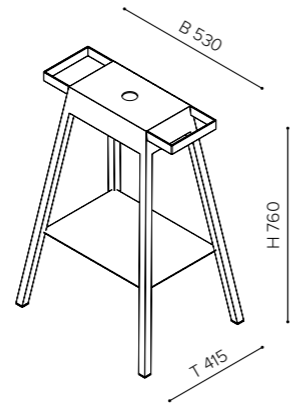

Piletta Ablaufventil, Basisring und Spezial Designsiphon sind als Anschlusszubehör erforderlich



Gestell Schwarz matt
BLOOMNO

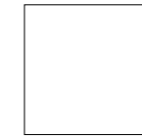

Gestell Weiß matt
BLOOMBO



MOVE PLUS

- Untergestell für Aufsatzbecken
- Kombinierbar mit Aufsatzbecken mit einem Durchmesser bis max. 40 cm
- Metallmöbel mit integrierter Ablage und Handtuchhaltern
- Maße: B 345 x T 340 x H 785 mm
- ohne Armaturenlochbohrung
- Material Möbel: Metall beschichtet in Schwarz matt oder Weiß matt

Hinweis: Das MOVE PLUS Metallmöbel wird mit einem Abstand zur Wand montiert.

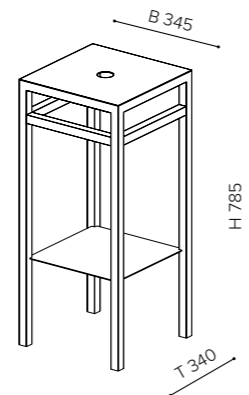

Piletta Ablaufventil, Basisring und Spezial Designsiphon sind als Anschlusszubehör erforderlich



Gestell Schwarz matt
MOVENO



Gestell Weiß matt
MOVEBO



ELLE PLUS

- Waschtisch mit Untergestell
- Waschtisch ELLE 480 x 420 mm Weiß, Schwarz, Silber oder Gold
- ohne Armaturenlochbohrung (Die Becken in Weiß und Schwarz sind auf Wunsch auch mit Armaturen-Lochbohrung für Einlocharmatur lieferbar)
- Material Waschtisch: VetroFreddo
- Metallmöbel mit integrierter Ablage und Handtuchhaltern
- Maße: B 480 x T 420 x H 900 mm
- Material Möbel: Metall beschichtet in Schwarz matt, Weiß matt oder Alt Messing

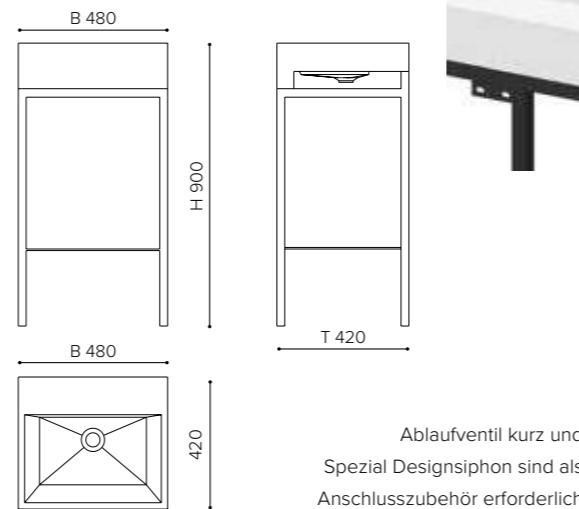

Ablaufventil kurz und Spezial Designsiphon sind als Anschlusszubehör erforderlich

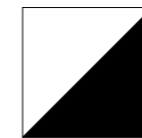

Becken Weiß matt /
Gestell Schwarz matt
ELLEPLUSNOPO01



Becken Schwarz matt /
Gestell Schwarz matt
ELLEPLUSNOPO30A



Becken Blattsilber /
Gestell Schwarz matt
ELLEPLUSNOFAAS



Becken Blattgold /
Gestell Schwarz matt
ELLEPLUSNOFOAS



Becken Schwarz matt /
Gestell Weiß matt
ELLEPLUSBOPO30A



Becken Blattsilber /
Gestell Weiß matt
ELLEPLUSBOFAAS



Becken Blattgold /
Gestell Weiß matt
ELLEPLUSBOFOAS

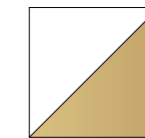

Becken Weiß matt /
Gestell Alt Messing
ELLEPLUSOBPO01



Becken Schwarz matt /
Gestell Alt Messing
ELLEPLUSOBPO30A



ITALY PLUS

- Waschtisch mit Untergestell
- Waschtisch ITALY FL 716 x 516 mm
Weiß oder Schwarz
- inkl. Armaturenlochbohrung für Einloch-
armatur (Auf Wunsch auch für Dreiloch-
armatur oder ohne Armaturen-
Lochbohrung lieferbar)
- Material Waschtisch: VetroFreddo
- Metallmöbel mit integrierter Ablage und
Handtuchhaltern
- Maße: B 810 x T 520 x H 885 mm
- Material Möbel: Metall beschichtet
in Schwarz matt, Weiß matt oder
Alt Messing

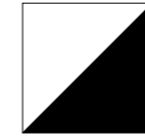
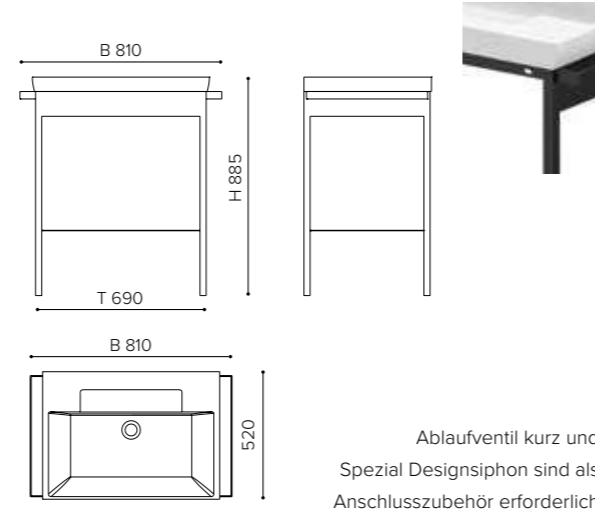

Becken Weiß matt /
Gestell Schwarz matt
ITALYPLUSNOPO01

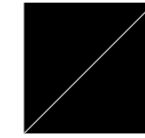

Becken Schwarz matt /
Gestell Schwarz matt
ITALYPLUSNOPO30AS



Becken Schwarz matt /
Gestell Weiß matt
ITALYPLUSBOPO30AS

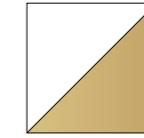

Becken Weiß matt /
Gestell Alt Messing
ITALYPLUSOBPO01



Becken Schwarz matt /
Gestell Alt Messing
ITALYPLUSOBPO30AS



DAME SPIEGEL

- mit LED Beleuchtung
- oval
- MDF
- Maße: H 1900 x B 1000 mm

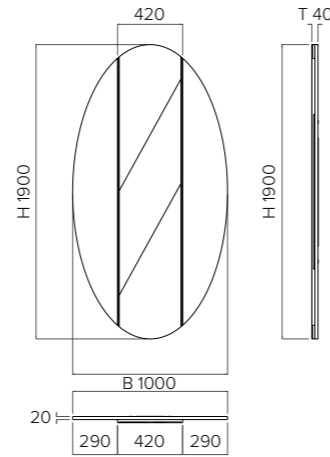

Weiß matt
DAMEMIRBO



Weiß glänzend
DAMEMIRBLAS



Schwarz matt
DAMEMIRNOAS



Ferrari Rot
DAMEMIRPL34AS



Gelb matt
DAMEMIRP102AS



Puder Pink matt
DAMEMIRP202AS



Salbei Grün matt
DAMEMIRP302AS



Avio Blau matt
DAMEMIRP402AS



Grau matt
DAMEMIRP450AS



Anthrazit matt
DAMEMIRP650AS



Blattsilber 3D
DAMEMIRFAAS



Blattgold 3D
DAMEMIRFOAS



SPIEGEL METROPOLE

- rund
- MDF mit aufgebürsteter Metallstruktur
- Maße: Ø 700 mm

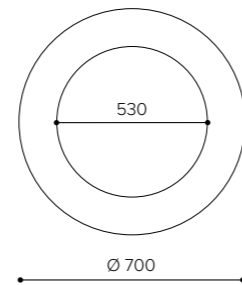

Weiß
FLOMIRROMWT



Silber
FLOMIRROMSL



Gold
FLOMIRROMGD



Gold Pink
FLOMIRROMPG



Platin
FLOMIRROMPL



Bronze
FLOMIRROMBZ



Anthrazit
FLOMIRROMAT



Blau
FLOMIRROMBL



Aquamarine
FLOMIRROMTF



SPIEGEL TONDO

- rund
- MDF
- Maße: Ø 700 mm

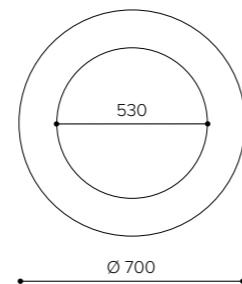

Weiß glänzend
FLOMIRROBL



Weiß matt
FLOMIRROBO



Schwarz glänzend
FLOMIRRONL



Schwarz matt
FLOMIRRONO



Ferrari Rot
FLOMIRROPL34



Gold (Blattauflage 3D)
FLOMIRROFO



Silber (Blattauflage 3D)
FLOMIRROFA



Gold matt
FLOMIRROGD



Inox matt
FLOMIRRODI



SPIEGEL TONDO XL

- rund
- MDF
- Maße: Ø 1000 mm

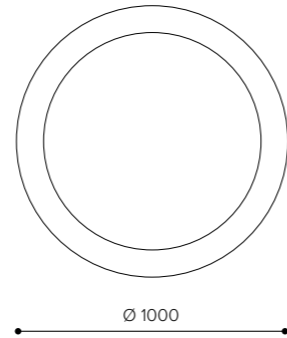

Weiß glänzend
FLOMIRRO100BL



Weiß matt
FLOMIRRO100BO



Schwarz glänzend
FLOMIRRO100NL



Schwarz matt
FLOMIRRO100NO



Gold (Blattauflage 3D)
FLOMIRRO100FO



Silber (Blattauflage 3D)
FLOMIRRO100FA



SPIEGEL OVAL

- oval
- MDF
- Maße: H 950 x B 650 mm

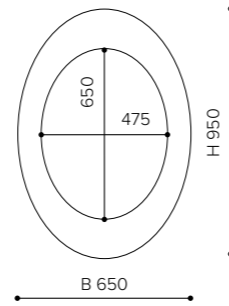

Weiß glänzend
FLOMIROVBL



Weiß matt
FLOMIROVBO



Schwarz glänzend
FLOMIROVNL



Schwarz matt
FLOMIROVNO



Ferrari Rot
FLOMIROVPL34



Gold (Blattauflage 3D)
FLOMIROVFO



Silber (Blattauflage 3D)
FLOMIROVFA



Gold matt
FLOMIROVGD



Inox matt
FLOMIROVDI



METALL SPIEGEL 40

- rechteckig
- Spiegel mit Metallrahmen
- Maße: H 800 x B 400 mm

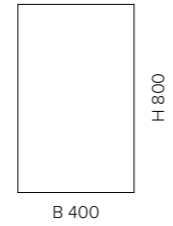

Spiegelrahmen Schwarz matt
METMIROX80NO



Spiegelrahmen Weiß matt
METMIR40X80BO



Spiegelrahmen Alt Messing
METMIR40X80OB



METALL SPIEGEL 47

- rechteckig
- Spiegel mit Metallrahmen
- Maße: H 900 x B 475 mm

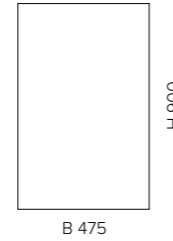

Spiegelrahmen Schwarz matt
METMIR47X90NO



Spiegelrahmen Weiß matt
METMIR47X90BO



Spiegelrahmen Alt Messing
METMIR47X90OB



METALL SPIEGEL 58

- rechteckig mit abgerundeten Ecken
- Spiegel mit Metallrahmen
- Maße: H 1000 x B 580 mm

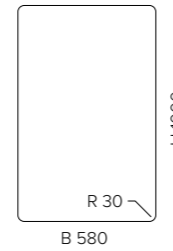

Spiegelrahmen Schwarz matt
METMIR58X100NO



Spiegelrahmen Weiß matt
METMIR58X100BO



Spiegelrahmen Alt Messing
METMIR58X100OB



METALL SPIEGEL TONDO 60

- rund
- Spiegel mit Metallrahmen
- Maße: Ø 600 mm

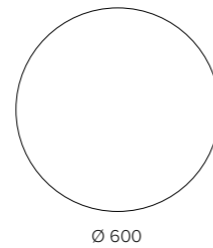

Spiegelrahmen Schwarz matt
METMIR60NO



Spiegelrahmen Weiß matt
METMIR60BO



Spiegelrahmen Alt Messing
METMIR60OB



FLOWER STYLE 2

Freistehende Badewanne

- Material: VetroFreddo Compact
- Gewicht: 130 kg
- Maße: B 1750 x T 835 x H 933 mm
- Fassungsvermögen: ca 295 Liter
- Inklusive integriertem Überlauf, vormontiertem Ablaufsystem
- Ablaufabdeckung Weiß matt bzw. Weiß glänzend und Sifon

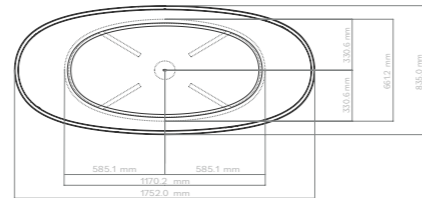
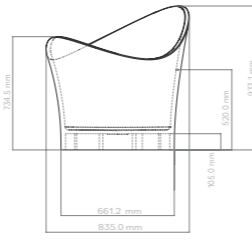
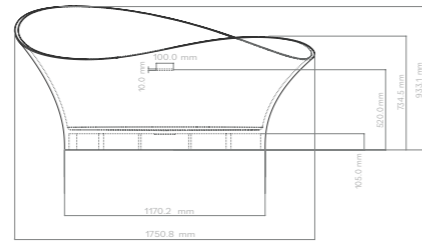

Achtung:
Unterhalb des Badewannenablaufs ist eine Aussparung im Boden im Maß B 300 x T 400 x H 120mm erforderlich.



Weiß glänzend
FLOSTYBLAS



Weiß matt
FLOSTYPO01



Schwarz matt/ Weiß matt
FLOSTYBLP01AS



Schwarz glänzend/ Weiß matt
FLOSTYBLGPO01AS



Ferrari Rot/ Weiß matt
FLOSTYRDP001AS



Gold matt/ Weiß matt
FLOSTYGDPO01AS



Dark INOX matt/ Weiß matt
FLOSTYDIP001AS



Silber (Blattauflage 3D) /
Weiß matt
FLOSTYFAP001AS



Gold (Blattauflage 3D) /
Weiß glänzend
FLOSTYFOWAS



Gold (Blattauflage 3D) /
Weiß matt
FLOSTYFOP001AS



MINI STYLE 2

- Mini-Eckbadewanne
- Material: VetroFreddo Compact
- Gewicht: 96 kg
- Maße: 1112 x 797 x H 760mm
- Fassungsvermögen: ca 200 Liter
- Inklusive integriertem Überlauf, vormontiertem Ablaufsystem
- Ablaufabdeckung Weiß matt bzw. Weiß glänzend und Sifon

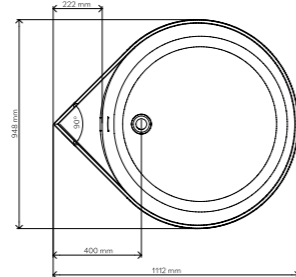
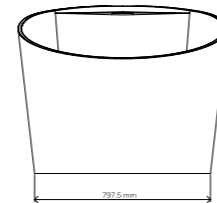
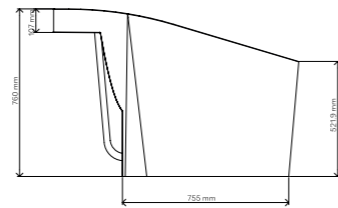

Achtung:
Unterhalb des Badewannenablaufs ist eine Aussparung im Boden im Maß B 300 x T 400 x H 120mm erforderlich.



Weiß glänzend
MINIBLAS



Weiß matt
MINIPO01



Ferrari Rot/Weiß matt
MINIRDPO01AS



Schwarz matt/Weiß matt
MINIBLPO01AS



Schwarz glänzend/Weiß matt
MINIBLGPO01AS



Dark INOX matt/ Weiß matt
MINIDIPO01AS



Gold matt/Weiß matt
MINIGDPO01AS



Silber (Blattauflage 3D)
Weiß matt
MINIFAPO01AS



Gold (Blattauflage 3D) /
Weiß matt
MINIFOP001AS

Das passende Zubehör finden Sie ab Seite 408

Hinweis: Bei allen Glasbecken sind kleine Lufteinschlüsse nicht zu vermeiden und gehören zu diesen handgemachten Unikaten ganz selbstverständlich dazu.

Alle Badewannen mit Ausnahme der Modelle in der Farbe Weiß matt werden serienmäßig mit AntiScratch Oberfläche geliefert. Technische Informationen und Montageanleitungen zu den Produkten entnehmen Sie bitte dem entsprechenden Datenblatt auf unserer Homepage myglassdesign.de/produkte. Aus drucktechnischen Gründen sind bei einzelnen Abbildungen Farbabweichungen nicht auszuschließen.



GLAMOROUS CLIVIA

- Kristallhandgriff 24% pb
- Griffboden in Chrom, Platin, Platin matt, Messing matt oder Dark Platinum
- 2er Set

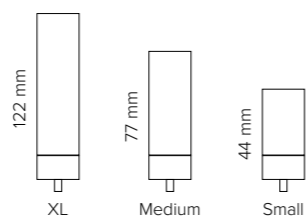

Ø 39
Kristallhandgriff zu Dornbracht MEM Seitenventilen
Alle technischen Informationen sind der Preisliste zu entnehmen.



GLAMOROUS ICE

- Kristallhandgriff 24% pb
- Griffboden in Chrom, Platin, Platin matt, Messing matt oder Dark Platinum
- 2er Set

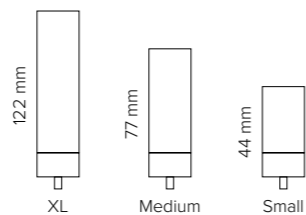

Ø 39
Kristallhandgriff zu Dornbracht MEM Seitenventilen
Alle technischen Informationen sind der Preisliste zu entnehmen.

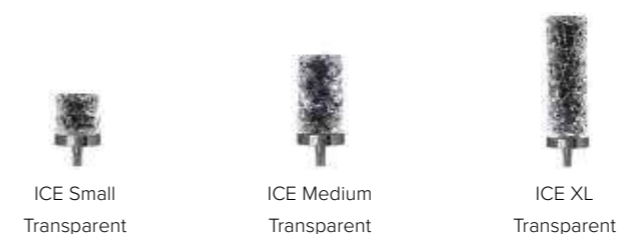

GLAMOROUS LUXOR

- Kristallhandgriff 24% pb
- Griffboden in Chrom, Platin, Platin matt, Messing matt oder Dark Platinum
- 2er Set

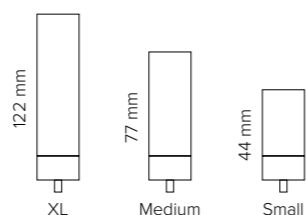

Ø 39
Kristallhandgriff zu Dornbracht MEM Seitenventilen
Alle technischen Informationen sind der Preisliste zu entnehmen.



GLAMOROUS RAMADA

- Kristallhandgriff 24% pb
- Griffboden in Chrom, Platin, Platin matt, Messing matt oder Dark Platinum
- 2er Set

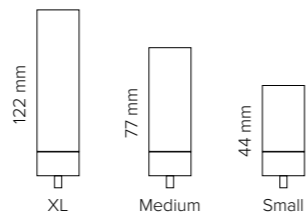

Ø 39
Kristallhandgriff zu Dornbracht MEM Seitenventilen
Alle technischen Informationen sind der Preisliste zu entnehmen.

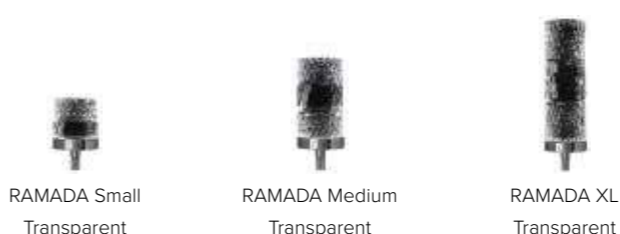

REGENTS KING SMALL & XL

- Kristallhandgriff 24% pb
- Griffboden in Chrom, Platin, Platin matt, Messing matt oder Dark Platinum
- Small: Maße: H43 x D60 mm
- XL: Maße: H122 x D60 mm
- 2er Set

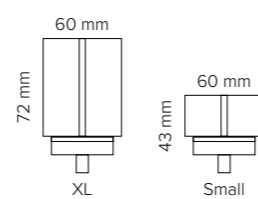

XL & Small
Kristallhandgriff zu Dornbracht MEM Seitenventilen
Alle technischen Informationen sind der Preisliste zu entnehmen.



REGENTS QUEEN SMALL & XL

- Kristallhandgriff 24% pb
- Griffboden in Chrom, Platin, Platin matt, Messing matt oder Dark Platinum
- Small: Maße: H43 x D60 mm
- XL: Maße: H122 x D60 mm
- 2er Set

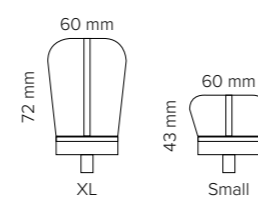

XL & Small
Kristallhandgriff zu Dornbracht MEM Seitenventilen
Alle technischen Informationen sind der Preisliste zu entnehmen.



Hinweis: Bei allen Glashandgriffen sind kleine Luftpinschlüsse nicht zu vermeiden und gehören zu diesen handgemachten Unikaten ganz selbstverständlich dazu.

Aus drucktechnischen Gründen sind bei einzelnen Abbildungen Farbabweichungen nicht auszuschließen.



TOWER ICE

- Kristallhandgriff 24% pb
- Griffboden in Chrom, Platin, Platin matt, Messing matt oder Dark Platinum
- 2er Set

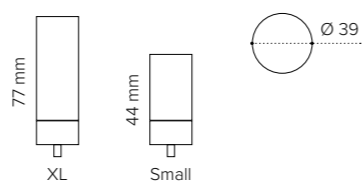

Kristallhandgriff zu Dornbracht MEM Seitenventilen
Alle technischen Informationen sind der Preisliste zu entnehmen.

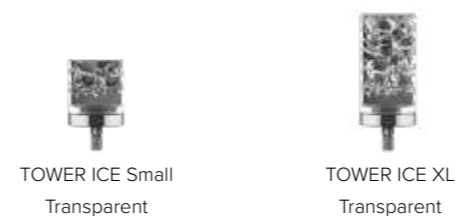

TOWER RAMADA

- Kristallhandgriff 24% pb
- Griffboden in Chrom, Platin, Platin matt, Messing matt oder Dark Platinum
- 2er Set

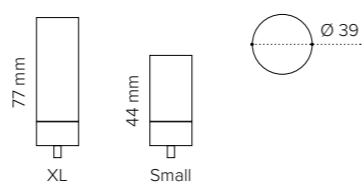

Kristallhandgriff zu Dornbracht MEM Seitenventilen
Alle technischen Informationen sind der Preisliste zu entnehmen.

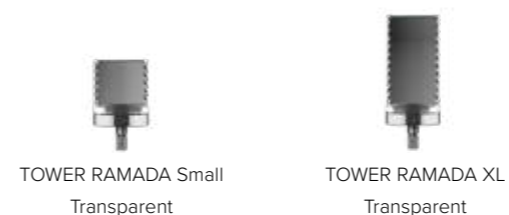

TOWER CLIVIA

- Kristallhandgriff 24% pb
- Griffboden in Chrom, Platin, Platin matt, Messing matt oder Dark Platinum
- 2er Set

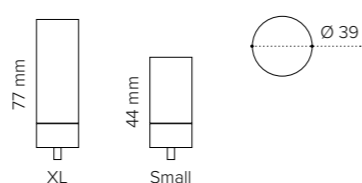

Kristallhandgriff zu Dornbracht MEM Seitenventilen
Alle technischen Informationen sind der Preisliste zu entnehmen.

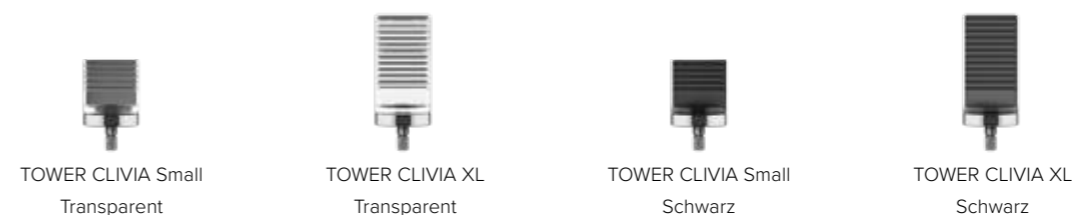

TOWER

- Kristallhandgriff 24% pb
- Griffboden in Chrom, Platin, Platin matt, Messing matt oder Dark Platinum
- 2er Set

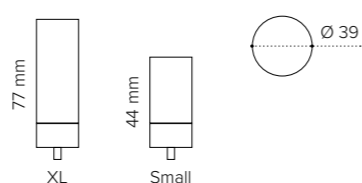

Kristallhandgriff zu Dornbracht MEM Seitenventilen
Alle technischen Informationen sind der Preisliste zu entnehmen.

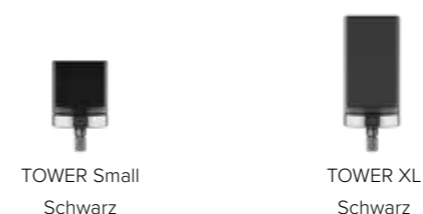

TOWER MARBLE CALACATTA

- Marmorhandgriff
- Griffboden in Chrom, Platin, Platin matt, Messing matt oder Dark Platinum
- 2er Set

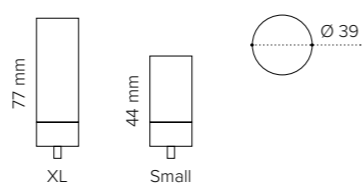

Marmorhandgriff zu Dornbracht MEM Seitenventilen
Alle technischen Informationen sind der Preisliste zu entnehmen.



TOWER MARBLE MARQUINA

- Marmorhandgriff
- Griffboden in Chrom, Platin, Platin matt, Messing matt oder Dark Platinum
- 2er Set

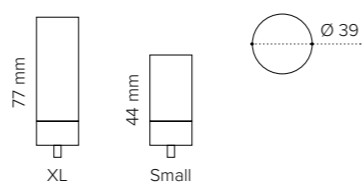

Kristallhandgriff zu Dornbracht MEM Seitenventilen
Alle technischen Informationen sind der Preisliste zu entnehmen.

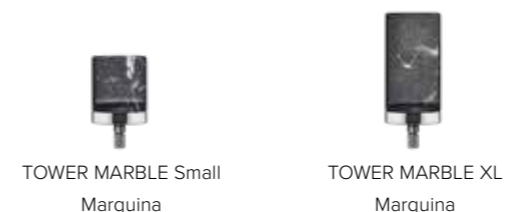



LYRIC ICE

- Kristallhandgriff 24% pb
- Griffboden in Chrom, Platin, Platin matt, Messing matt, Schwarz matt oder Dark Platinium
- 2er Set

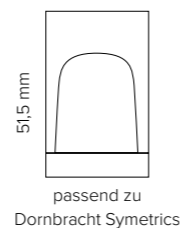
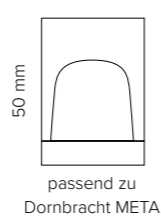

Kristallhandgriff zu Dornbracht META bzw. Symetrics Seitenventilen
Alle technischen Informationen sind der Preisliste zu entnehmen.



Gold



Silber



Platin

Weitere Farben passend zum SCENIC ICE Becken auf Anfrage verfügbar



LYRIC CLIVIA

- Kristallhandgriff 24% pb
- Griffboden in Chrom, Platin, Platin matt, Messing matt, Schwarz matt oder Dark Platinium
- 2er Set

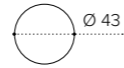
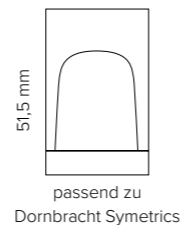
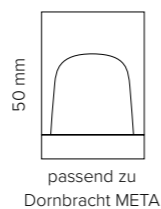

Kristallhandgriff zu Dornbracht META bzw. Symetrics Seitenventilen
Alle technischen Informationen sind der Preisliste zu entnehmen.



Gold



Silber



Schwarz



LYRIC LUXOR

- Kristallhandgriff 24% pb
- Griffboden in Chrom, Platin, Platin matt, Messing matt, Schwarz matt oder Dark Platinium
- 2er Set

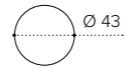
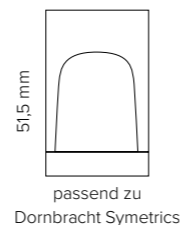
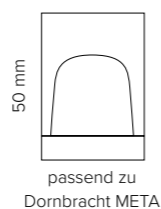

Kristallhandgriff zu Dornbracht META bzw. Symetrics Seitenventilen
Alle technischen Informationen sind der Preisliste zu entnehmen.



Gold



Silber



Schwarz



LYRIC RAMADA

- Kristallhandgriff 24% pb
- Griffboden in Chrom, Platin, Platin matt, Messing matt oder Dark Platinium
- 2er Set

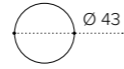
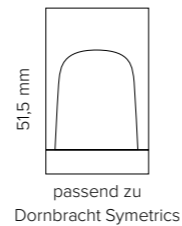
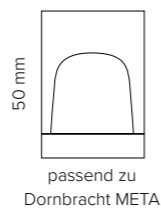

Kristallhandgriff zu Dornbracht META bzw. Symetrics Seitenventilen
Alle technischen Informationen sind der Preisliste zu entnehmen.



Gold



Silber



Platin

Weitere Farben passend zum SCENIC RAMADA Becken auf Anfrage verfügbar



LYRIC METROPOLE

- Kristallhandgriff 24% pb
- Griffboden in Chrom, Platin, Platin matt, Messing matt, Schwarz matt oder Dark Platinium
- 2er Set

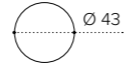
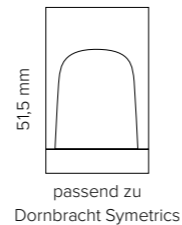
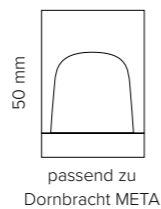

Kristallhandgriff zu Dornbracht META bzw. Symetrics Seitenventilen
Alle technischen Informationen sind der Preisliste zu entnehmen.



Anthrazit



Bronze



Platin

Weitere METROPOLE Farben auf Anfrage verfügbar



LYRIC

- Kristallhandgriff 24% pb
- Griffboden in Chrom, Platin, Platin matt, Messing matt, Schwarz matt oder Dark Platinium
- 2er Set

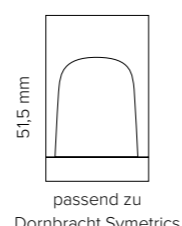
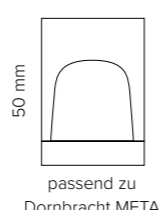

Kristallhandgriff zu Dornbracht META bzw. Symetrics Seitenventilen
Alle technischen Informationen sind der Preisliste zu entnehmen.



Gold



Silber



Schwarz



Weiß



LYRIC PREMIUM

- Kristallhandgriff 24% pb
- Griffboden in Chrom, Platin, Platin matt, Messing matt, Schwarz matt oder Dark Platinum
- 2er Set



Kristallhandgriff zu Dornbracht META bzw. Symetrics Seitenventilen
Alle technischen Informationen sind der Preisliste zu entnehmen.



Gold



Silber



Gewittergrau

Weitere Farben passend zum PREMIUM Becken auf Anfrage verfügbar



LYRIC MARBLE

- Marmorhandgriff
- Griffboden in Chrom, Platin, Platin matt, Messing matt, Schwarz matt oder Dark Platinum
- 2er Set

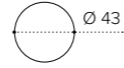
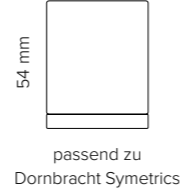
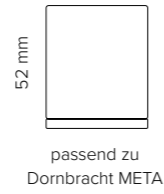

Kristallhandgriff zu Dornbracht META bzw. Symetrics Seitenventilen
Alle technischen Informationen sind der Preisliste zu entnehmen.



Calacatta



Marquina



OPERA BÜRSTENGARNITUR

- Dekor Ramada
- Material: Bleikristall 24%pb

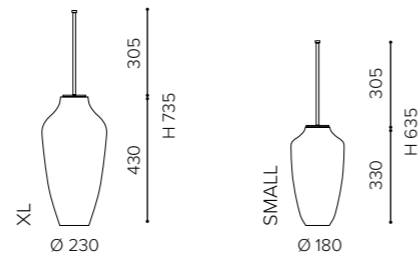

- XL
- Transparent/Chrom
OPERAXLT01F4
 - Transparent/Gold
OPERAXLT01F3



- SMALL
- Transparent/Chrom
OPERAST01F4
 - Transparent/Gold
OPERAST01F3



CANTO BÜRSTENGARNITUR

- Dekor ICE
- Material: Bleikristall 24%pb

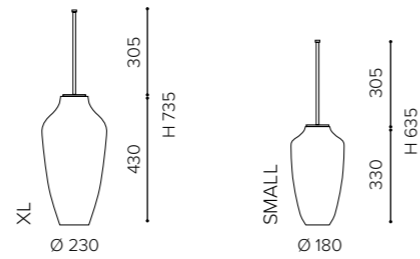

- XL
- Transparent/Chrom
CANTOXL01F4
 - Transparent/Gold
CANTOXL01F3



- SMALL
- Transparent/Chrom
CANTOST01F4
 - Transparent/Gold
CANTOST01F3



VALENTINO 1 (KRISTALLGLAS BECHER)

- Glasbecher
- Material: Bleikristall 24%pb



VALENTINO 2 (RAUMDUFTGLAS)

- Raumduftglas mit Holzstäbchen
- Material: Bleikristall 24%pb

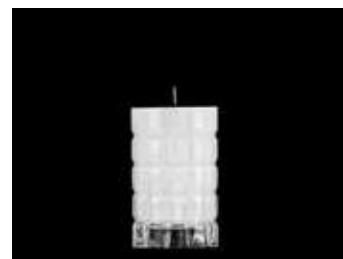
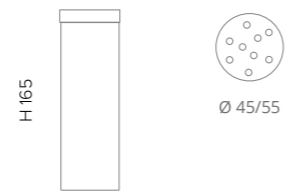

VALENTINO 3 (DUFTKERZE)

- Glas mit Duftkerze
- Material: Bleikristall 24%pb



VALENTINO 4 (SEIFENSPENDER)

- Seifenspender
- Material: Bleikristall 24%pb

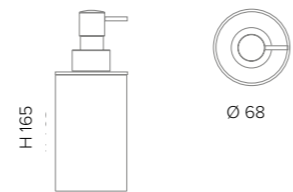

Hinweis: Bei allen Glasaccessoires sind kleine Luft einschüsse nicht zu vermeiden und gehören zu diesen handgemachten Unikaten ganz selbstverständlich dazu.

Aus drucktechnischen Gründen sind bei einzelnen Abbildungen Farbabweichungen nicht auszuschließen.



ROYAL SEIFENSPENDER

- Seifenspender
- Material: Kristallglas

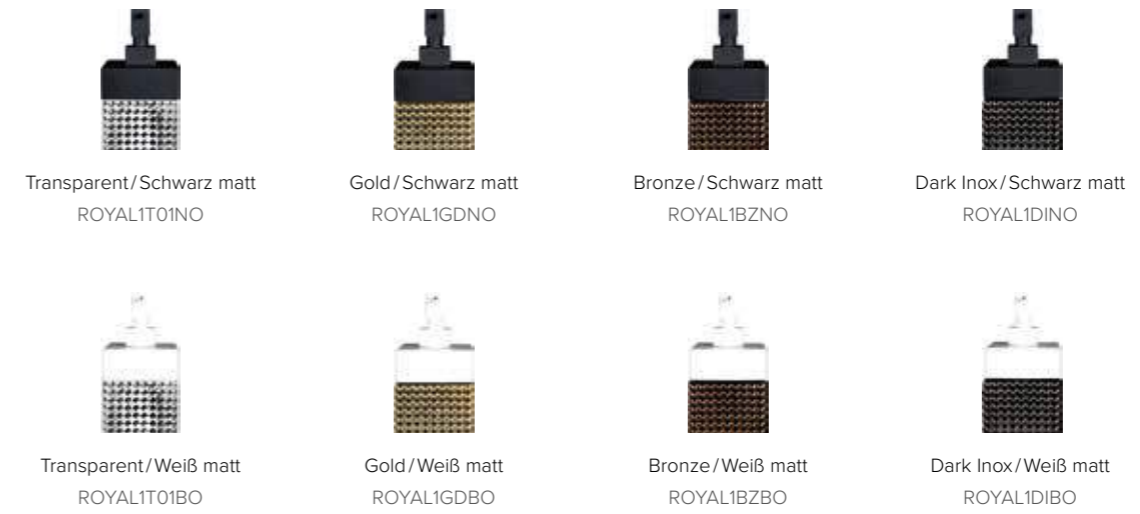
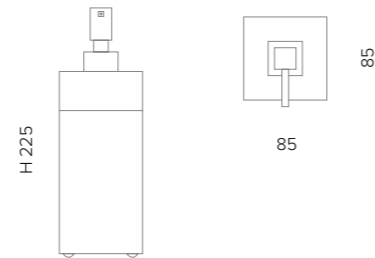

ROYAL SEIFENABLAGE MIT BECHER

- Ablage mit integrierter Seifenschale
- Material: VetroFreddo und Becher Kristallglas

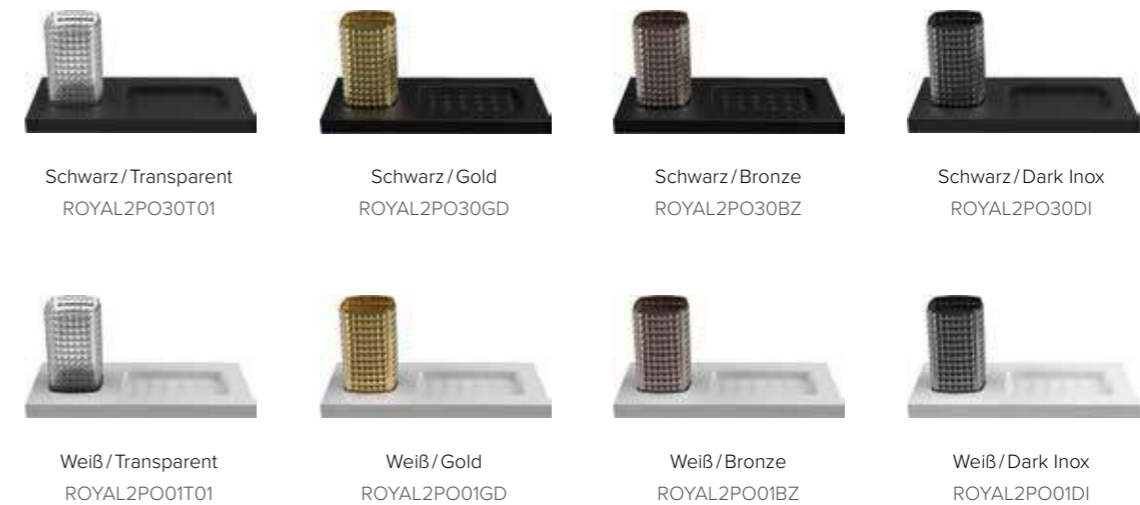
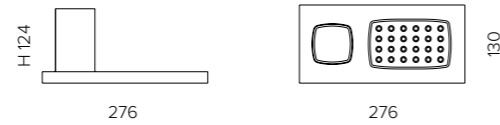

ARIA UNO ABLAGE MIT EINSATZ

- Maße: B 300 x H 30 x T 140 mm
- Material: Metallablage (Edelstahl) mit Einleger aus VetroFreddo

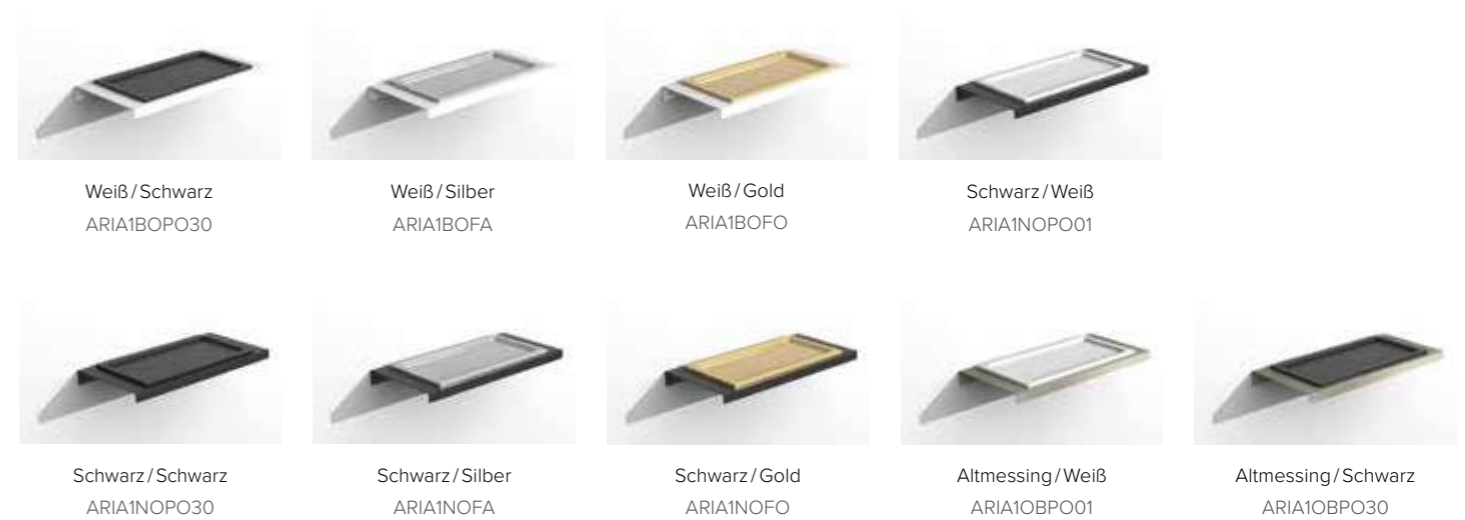
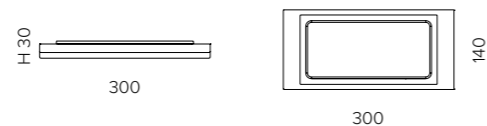

Hinweis: Bei allen Glasaccessoires sind kleine Luft einschüsse nicht zu vermeiden und gehören zu diesen handgemachten Unikaten ganz selbstverständlich dazu.

Aus drucktechnischen Gründen sind bei einzelnen Abbildungen Farbabweichungen nicht auszuschließen.



ARIA DUE ABLAGE MIT SEIFEN- SCHALE UND BECHER

- Maße: B 300 x H 93 x T 140 mm
- Material: Metallablage (Edelstahl)
- Becher und Seifenablage: VetroFreddo

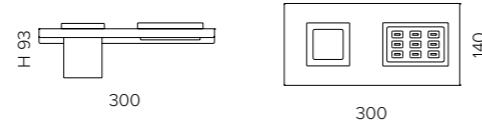

Weiß/Schwarz
ARIA2BOPO30



Weiß/Silber
ARIA2BOFA



Weiß/Gold
ARIA2BOFO



Schwarz/Weiß
ARIA2NOPO01



Schwarz/Schwarz
ARIA2NOPO30



Schwarz/Silber
ARIA2NOFA



Schwarz/Gold
ARIA2NOFO



Altmessing/Weiß
ARIA2OBPO01



Altmessing/Schwarz
ARIA2OBPO30



ARIA TRE SMALL ABLAGE

- Maße: B 360 x H 29 x T 120 mm
- Material: Edelstahl

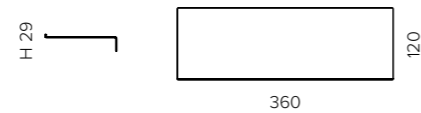

Schwarz
ARIA3SNO



Weiß
ARIA3SBO



Altmessing
ARIA3SOB



ARIA TRE LARGE ABLAGE

- Maße: B 480 x H 29 x T 120 mm
- Material: Edelstahl

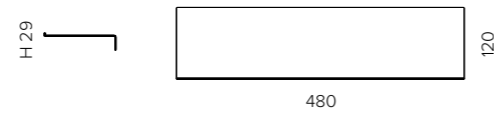

Schwarz
ARIA3LNO



Weiß
ARIA3LBO



Altmessing
ARIA3LOB



METROPOLE SEIFENSCHALE

- Seifenschale
- Material: VetroFreddo

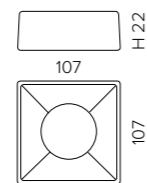

Silber
METO1SL



Gold
METO1GD



Platin
METO1PL



Bronze
METO1BZ



Gold Pink
METO1BZ



Anthrazit
METO1AT



Blau
METO1BL



Aquamarin
METO1TF



Weiß
METO1WT

Aus drucktechnischen Gründen sind bei einzelnen Abbildungen Farbabweichungen nicht auszuschließen.



**METROPOLE
BECHER**

- Becher
- Material: Glas/Edelstahl

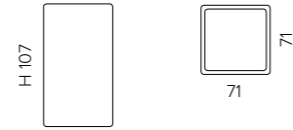

Silber
MET02SL



Gold
MET02GD



Platin
MET02PL



Bronze
MET02BZ



Gold Pink
MET02PG



Anthrazit
MET02AT



Blau
MET02BL



Aquamarine
MET02TF



Weiß
MET02WT



**METROPOLE
SEIFENSPENDER**

- Seifenspender
- Material: VetroFreddo
- Pumpe: Chrom

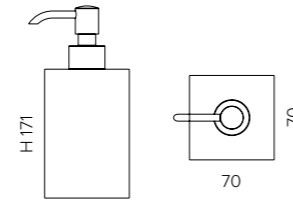

Silber
MET03SLF4



Gold
MET03GDF4



Platin
MET03PLF4



Bronze
MET03BZF4



Gold Pink
MET03PGF4



Anthrazit
MET03ATF4



Blau
MET03BLF4



Aquamarine
MET03TF4



Weiß
MET03WTF4



**LINEA
BECHER**

- Becher
- Material: Glas



Gewittergrau
LINEA2T45



Rubinrot
LINEA2T16



Petrol
LINEA2T40



Orange
LINEA2T38



**LINEA
SEIFENSPENDER**

- Seifenspender
- Material: Glas



Gewittergrau
LINEA1T45F4



Rubinrot
LINEA1T16F4



Petrol
LINEA1T40F4



Orange
LINEA1T38F4



GRAFFITI 2 BECHER

- Becher
- Material: Glas

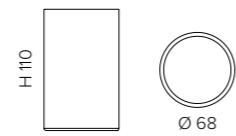

Silber-Schwarz
GRAFT02SB



Weiß-Gold
GRAFT02WG



Schwarz-Gold
GRAFT02BG



Rot-Gold
GRAFT02RO



GRAFFITI 2 SEIFENSPENDER

- Seifenspender
- Material: Glas
- Pumpe: Edelstahl matt

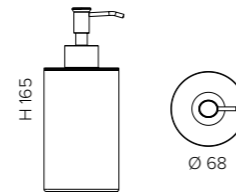

Silber-Schwarz
GRAFT03SBF4



Weiß-Gold
GRAFT03WGF4



Schwarz-Gold
GRAFT03BGF4



Rot-Gold
GRAFT03ROF4



GRAFFITI 2 DUFTSPENDER

- Raumduftglas mit Holzstäbchen
- Material: Glas

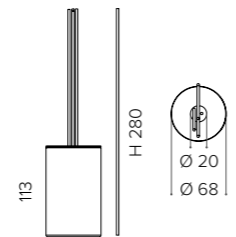

Silber-Schwarz
GRAFT04SBF4



Weiß-Gold
GRAFT04WGF4



Schwarz-Gold
GRAFT04BGF4



Rot-Gold
GRAFT04ROF4



LUNA BECHER

- Becher
- Material: Glas

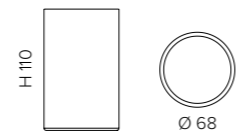

Grau
LUNA02GR



Sand
LUNA02SN



Weiß
LUNA02WT



LUNA SEIFENSPENDER

- Seifenspender
- Material: Glas
- Pumpe: Edelstahl

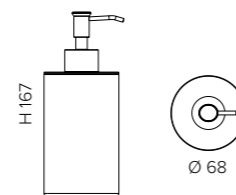

Grau/Chrom
LUNA03GRF4



Sand/Chrom
LUNA03SNF4



Weiß/Chrom
LUNA03WTF4



LUXURY SEIFENSCHALE

- Seifenschale
- Material: Glas mit Blattauflage
Einleger Edelstahl

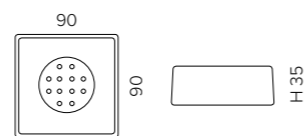

Silber Blattauflage 3D
LUX01FA



Gold Blattauflage 3D
LUX01FO



Kupfer Blattauflage 3D
LUX01FR

Hinweis: Bei allen Glasaccessoires sind kleine Luft einschüsse nicht zu vermeiden und gehören zu diesen handgemachten Unikaten ganz selbstverständlich dazu.

Aus drucktechnischen Gründen sind bei einzelnen Abbildungen Farbabweichungen nicht auszuschließen.



LUXURY BECHER

- Becher
- Material: Glas mit Blattauflage

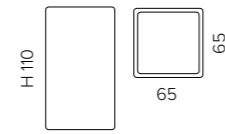

Silber Blattauflage 3D
LUX02FA



Gold Blattauflage 3D
LUX02FO



Kupfer Blattauflage 3D
LUX02FR



LUXURY SEIFENSPENDER

- Seifenspender
- Material: Glas mit Blattauflage
- Pumpe: Edelstahl matt

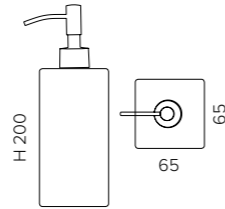

Silber Blattauflage 3D
LUX03FA



Gold Blattauflage 3D
LUX03FO



Kupfer Blattauflage 3D
LUX03FR



MODE LUX BECHER

- Raumduftglas mit Holzstäbchen
- Material: Glas

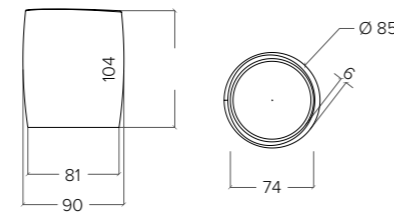

Graphit Grau/Bronze
MODE02GMBZ



Graphit Grau/Silber
MODE02GMSL



Graphit Grau/Gold
MODE02MGD



Graphit Grau/Dark Inox
MODE02GMDI



MODE LUX SEIFENSCHALE

- Seifenschale
- Material: Glas

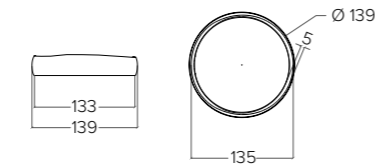

Graphit Grau/Bronze
MODE01GMBZ



Graphit Grau/Silber
MODE01GMSL



Graphit Grau/Gold
MODE01MGD



Graphit Grau/Dark Inox
MODE01GMDI



NAVY BECHER

- Becher
- Material: VetroFreddo

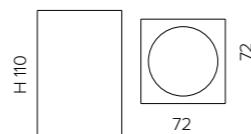

Weiß matt
NV02PO01



Schwarz matt
NV02PO30



Gelb
NV02P102



Puder Pink
NV02P202



Salbei Grün
NV02P302



Avio Blau
NV02P402



NAVY SEIFENSPENDER

- Seifenspender
- Material: VetroFreddo
- Pumpe: Chrom

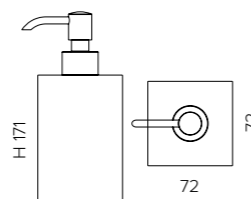

Weiß matt/Chrom
NV03PO01F4



Schwarz matt/Chrom
NV03PO30F4



Gelb/Chrom
NV03P102



Puder Pink/Chrom
NV03P202



Salbei Grün/Chrom
NV03P302



Avio Blau/Chrom
NV03P402

Hinweis: Bei allen Glasaccessoires sind kleine Luft einschüsse nicht zu vermeiden und gehören zu diesen handgemachten Unikaten ganz selbstverständlich dazu.

Aus drucktechnischen Gründen sind bei einzelnen Abbildungen Farbabweichungen nicht auszuschließen.



KOOL BECHER

- Becher
- Material: VetroFreddo

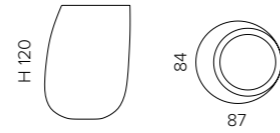

Weiß matt
KL02PO01



Schwarz matt
KL02PO30



KOOL SEIFENSPENDER

- Seifenspender
- Material: VetroFreddo
- Pumpe: Chrom

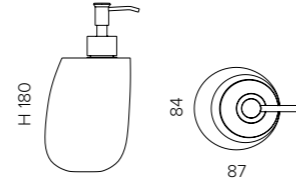

Weiß matt
KL03PO01F4



Schwarz matt
KL03PO30F4



CARRARA SEIFENSCHALE

- Seifenschale
- Material: Marmor

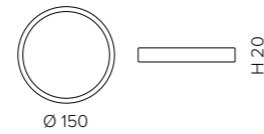

Weiß Calacatta
CARRARA1MARW



Schwarz Marquina
CARRARA1MARB



CARRARA BECHER

- Becher
- Material: Marmor

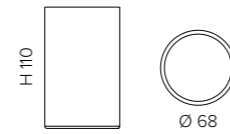

Weiß Calacatta
CARRARA2MARW



Schwarz Marquina
CARRARA2MARB



CARRARA SEIFENSPENDER

- Seifenspender
- Material: Marmor

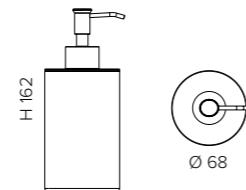

Weiß Calacatta
CARRARA3MARWF4



Schwarz Marquina
CARRARA3MARB4

PILETTA FREE FLOW

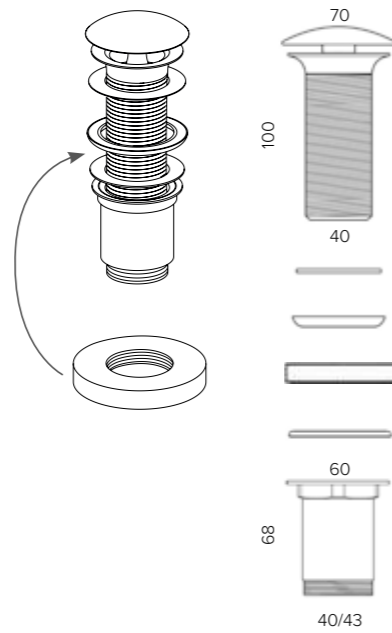

Ablaufventil Piletta GD
GD Waste

Ablaufventil ist bauseits kürzbar
Drain valve can be shortened on site

Dichtung Typ 1
Gasket Type 1

Im Waschbecken inbegriffen
Included in the washbasin

Dichtung Typ 2
Gasket Type 2

Basiring
brass ring

Dichtung Typ 3
Gasket Type 3

Verbindung
Connection

- bauseitig kürzbar
- nicht verschleißbares Ablaufventil
- nicht einsetzbar für die Metallbadmöbel mit Ausnahme von BloomPlus und MovePlus
- Material: Messing
- Maße: Ø 70 x H 100 mm

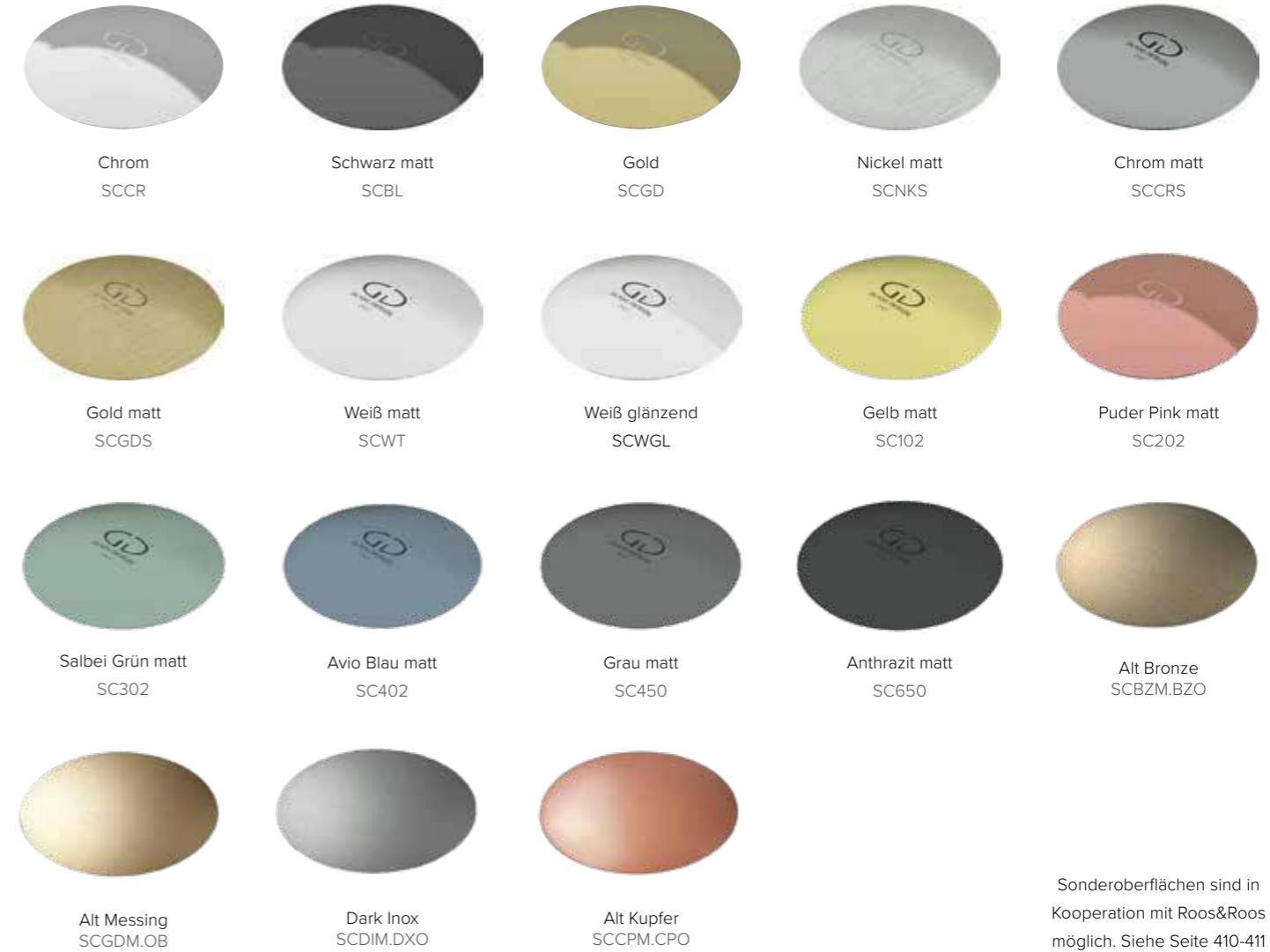

Sonderoberflächen sind in Kooperation mit Roos&Roos möglich. Siehe Seite 410-411

ABLAUFVENTIL FÜR METALLMÖBEL

- verkürztes Ablaufventil für die Kombination mit den Metallbadmöbel Serien mit Ausnahme von BloomPlus und MovePlus
- Material: Messing
- Maße: Ø 63 x H max. 70 mm

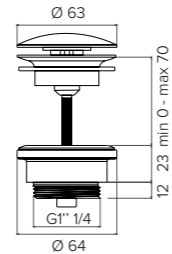

Inklusive Umrüstset für Push-To-Open Funktion



Sonderoberflächen sind in Kooperation mit Roos&Roos möglich. Siehe Seite 410-411

PILETTA CLIK CLAK

- verschleißbares Ablaufventil
- Nicht einsetzbar für die Metallbadmöbel
- Nicht kombinierbar mit Basiringen 2 & 3
- Material: Messing
- Maße: Ø 63,5 x H 100 mm

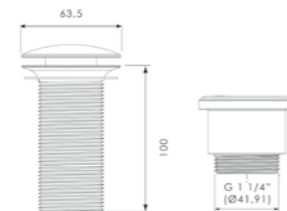

ACHTUNG:
Verschleißbare Ablaufventile dürfen nicht mit Becken ohne Überlauf kombiniert werden, wenn das Bad keinen Bodenablauf hat.



Sonderoberflächen sind in Kooperation mit Roos&Roos möglich. Siehe Seite 410-411



PILETTA AUTOMATICO

- Verschleißbares Ablaufventil mit automatischer Öffnung bei entsprechendem Wasserdruck
- Material: Messing
- Maße: Ø 63 x H 60 mm

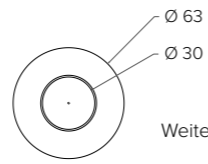
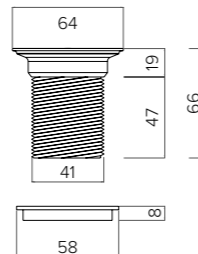

Nur in Kombination mit SLIDE Aufsatzbecken verwendbar
Weitere Becken-Kombinationen auf Anfrage möglich.



Chrom
SCCRFLO



Schwarz matt
SCBLFLO

Sonderoberflächen sind bei diesem Ablaufventil nicht möglich.



SONDERBESCHICHTUNG FÜR PILETTA ABLAUFVENTIL

Die Piletta Ablaufventile können in Kooperation mit der Firma Roos&Roos in Sonderoberflächen beschichtet werden.

Aufpreis zzgl. zum Chrom Ablaufventil

Preisgruppe 1 / RAL Farben
SCCRBESHPG1

Preisgruppe 2 / Galvanische Oberflächen
SCCRBESHPG2

Preisgruppe 3 / Gold
SCCRBESHPG3



ANELLO BASISRING

- Material: Messing
- Maße: Ø 85 x H 13 mm

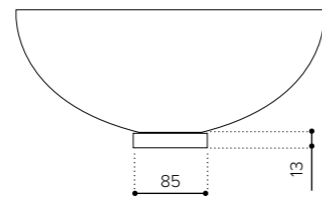

Chrom
ANF4



Schwarz matt
ANBL



Gold
ANF3



Nickel matt
ANNKS



Chrom matt
ANCRS



Gold matt
ANGDS



Alt Messing matt
ANWT



Dark Inox matt
ANWT



Alt Kupfer matt
ANWT



Alt Bronze matt
ANWT



Weiß matt
ANWT

Sonderoberflächen sind in Kooperation mit Roos&Roos möglich.



ANELLO BASISRING NO. 2 FÜR METROPOLE OVAL BECKEN

- Ausschließlich für das Modell Metropole Oval
- Material: Messing
- Maße: Ø 85 x H 13 mm

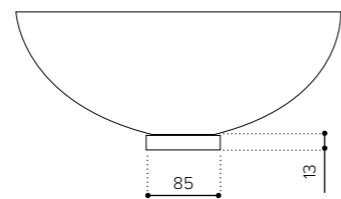

Chrom
ANF4.FL



Gold
ANF3.FL



Schwarz matt
ANBL.FL

Sonderoberflächen sind in Kooperation mit Roos&Roos möglich.



ANELLO BASISRING NO. 3 FÜR KATINO BECKEN

- Für die Modelle Metropole Katino, Luna Katino, Lusso Katino, Vento und Marea
- Material: Messing
- Maße: Ø 85 x H 13 mm

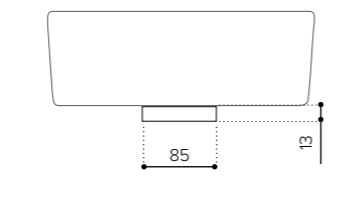

Chrom
ANF4.FL



Gold
ANF3.FL



Schwarz matt
ANBL.FL

Sonderoberflächen sind in Kooperation mit Roos&Roos möglich.

Aus drucktechnischen Gründen sind bei einzelnen Abbildungen Farbabweichungen nicht auszuschließen.



SONDERBESCHICHTUNG FÜR ANELLO BASISRINGE

Die Anello Basisringe können in Kooperation mit der Firma Roos&Roos in Sonderoberflächen beschichtet werden.

Aufpreis zzgl. zum Chrom Basisring

Preisgruppe 1 /
RAL Farben
ANF4BESH1PG1

Preisgruppe 2 /
Galvanische Oberflächen
ANF4BESH2PG2

Preisgruppe 3 /
Gold
ANF4BESH3PG3



SPEZIALSIPHON FÜR METALLMÖBEL

- verkürzter Designsiphon für die optimale Kombination mit den Metallmöbel Serien
- Material: Messing
- Maße: T max 290 x H 140 – 230 mm

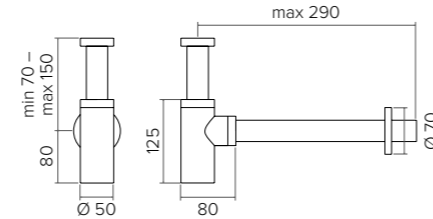

Chrom
SIFTF4



Gold
SIFTF3



Schwarz Matt
SIFTBL

Sonderoberflächen sind in Kooperation mit Roos&Roos möglich.



SONDERBESCHICHTUNG FÜR SPEZIALSIPHON

Die Spezialsiphons können in Kooperation mit der Firma Roos&Roos in Sonderoberflächen beschichtet werden.

Aufpreis zzgl. zum Chrom Siphon

Preisgruppe 1 /
RAL Farben
SIFTBESH1PG1

Preisgruppe 2 /
Galvanische Oberflächen
SIFTBESH2PG2

Preisgruppe 3 /
Gold
SIFTBESH3PG3



RACCORDO JOINT

- Ablauf für Standwaschtische; erforderlich für die Serien: Flower Evolution, Tommy, Tommy Metropole, TomTom2 und Tempo
- Material: Kunststoff
- Oberfläche: Verchromt
- Maße: L 500 mm; Anschluss Ø 32 mm

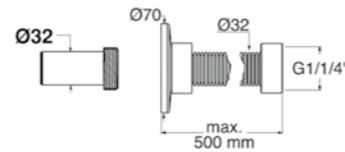

RACCORDO Joint flexible Ablaufverbindung für wandgebundene Standwaschtische, Verbindung vom Ablaufventil zum UP-Siphon



ALLGEMEINE INFORMATIONEN

Zur Reinigung ausschließlich Wasser oder PH-neutrale Reiniger verwenden. Um Kalkablagerungen vorzubeugen, sollten nach dem Gebrauch Wassertropfen mit einem weichen Tuch, Handtuch oder Fensterleder abgewischt werden

NICHT ZU VERWENDEN

Scheuermittel, Scheuerschwämme, Mikrofasertücher, Putzsteine, säurehaltige, chlorhaltige oder Alkohol enthaltende Mittel, bleichende Substanzen, Haarfärbemittel.

HINWEIS

Zahnpasta enthält bleichende Substanzen und sollte schnellst möglich entfernt werden. Sehr kalkhaltiges Wasser, kann bei Nichtreinigung über längere Zeit, die Oberfläche angreifen. Bei dunklen Farben in Verbindung mit kalkhaltigem Wasser ist ein Nachputzen mit einem weichen Tuch nach Gebrauch zu empfehlen.

Zur Reinigung und Pflege von Marmor empfehlen wir unseren STONE Pflegereiniger. Sparsam verwenden! Marmor-Pflegemittel sollten möglichst nicht mit dem Glas der Serien Skyline und Xtreme in Berührung kommen.

Bei den Materialien Siliconio und Marmo Calacatta kann das Becken sehr sparsam mit Olivenöl und einem fusselfreien Tuch ausgewischt werden, um einen Perl-effekt zu erhalten.

Serie	Katalog	Sortimentsübersicht
Accessoires	276–289	394–407
Ala 80	172	346–347
Anello Basisring	–	410–411
AntiScratch	–	410–413
Aqua	62	300–301
Aquarama	208–209	370–371
Aria Accessoires	281	396–399
Arius Home	272–275	–
Arte	114–118	322–325
Astro	59	300–301
Badewannen	230–235	384–385
Bamboo Katino	86–87	314–315
Barchetta	196	360–361
Basisring	–	410–411
Blade	187	354–357
Bloom Plus	222–223	374–375
Bubble	194–195	360–361
Canto Accessoires	278	394–395
Canto Small	278	394–395
Canto XL	278	394–395
Carrara Accessoires	289	406–407
Chelo	57	298–299
Circus 43	177	348–349
Circus 43 FL	178	348–349
Circus 43 Travertino	179	350–351
Circus 50	176	346–347
Circus 50 FL	178	348–349
Circus Oval (ehem. Flou)	175	346–347
Clivia	56	298–299
Cocoon	165	344–345
Cocoon 34	164	344–345
Colle	142	330–331
Collier	50	296–297
Collina	159	338–339
Collina 35	–	338–339
Collina Metropole	160	340–341
Collina 35 Metropole	161	340–341
Collina XL	162	338–339
Collina XL Metropole	163	340–341
Cristallo de Medici	32–67	292–303
Dame	202–203	362–363
Dame Haute Couture	204–205	364–365
Dame Spiegel	202–203	378–379
Elle Plus	226–227	374–375

Serie	Katalog	Sortimentsübersicht
Florence Glass Atelier	68–107	304–321
Flower	191	358–359
Flower Evolution	200–201	362–363
Flower Style 2	232–233	384–385
Four	186	354–355
Gala	96–97	316–317
Giotto	44	296–297
Glamorous Armaturengriffe	240–247	386–387
Glamorous Tuning	236–271	386–393
Glo Ball Crystal Ice	–	394–395
Glo Ball Murano	110–111	322–323
Graffiti	76–77	310–311
Graffiti 2 Accessoires	284	402–403
Graffiti 2.0	78–79	310–311
Gum	197	360–361
Ice Round 34	35	294–295
Ice Round 34 Lux	36–37	294–295
Ice Lux	36–37	294–295
Ice Oval	34	292–293
Ice Oval Small	34	292–293
Ice Round	35	294–295
Infinity	188–189	356–357
Infinity Over	158	344–345
Infinity Starlight	188–189	356–357
Italy Plus	228–229	376–377
Karim Rashid	86–89 / 194–195	–
King Armaturengriffe	260–261	386–387
Kalice	211	270–271
Khorus	210	364–365
Klio	82–85	312–313
Koko.2	174	346–347
Konka	173	346–347
Kool	168	340–341
Kool Accessoires	288	406–407
Kool Max	166–167	342–343
Kool Max Marble	122–125	326–327
Kool Oversize	169	342–343
Kool XL	171	342–343
Kool XL FL	170	344–345
Laguna	112–113	322–323
Lambo	213	370–371
Line Katino	92	316–317
Linea Accessoires	283	400–401
Luna	74	308–309

Serie	Katalog	Sortimentsübersicht
Luna Accessoires	285	402–403
Luna Katino	75	308–309
Lusso	80	312–313
Lusso Katino	81	312–313
Luxor Oval	47	296–297
Luxor Round	48–49	296–297
Luxury	286	402–405
Lyric Armaturengriffe	262–271	390–393
Marea Colour	86–87	314–315
Marea Home	89	314–315
Marea Lux	88	314–315
Marmo Calacatta	120–129	326–327
Metropole Accessoires	282	398–401
Metropole Katino	70–71	304–305
Metropole Oval	72	306–307
Metropole Round	73	304–307
Mini Style	234–235	384–385
Mode Classic	138	328–329
Mode Lux	132–137	328–329
Mode Lux Accessoires	287	404–405
Moon	64–65	302–303
Move Plus	224–225	374–375
Murano Glass	108–119	322–325
Navy Accessoires	288	404–405
Ocean	88–91	314–315
One	–	344–345
One Plus	220–221	372–373
Open	190	356–357
Opera Accessoires	278	394–395
Ottico	119	324–325
Oval Travertino	181	350–351
Pert	182–191	352–359
Piletta Ablaufventil	–	408–411
Polo Art	140	328–329
Polo Lux	139	328–329
Polo Metal	141	328–329
Premium	63	302–303
Queen Armaturengriffe	258–259	386–387
Raccordo Joint Ablauf	–	412–413
Ramada	51	296–297
Ramada Lux	52–53	298–299
Rapolano Travertino	180	350–351
Regents Armaturengriffe	258–261	386–387
Rho	184–185	352–353

Serie	Katalog	Sortimentsübersicht
Roos&Roos Beschichtung	–	410–413
Rose (ehem. Globo)	98–99 / 222–223	318–319
Rose Lux	225	318–319
Royal Absolute	66–67	302–303
Royal Accessoires	279	396–397
Satinato 44	101	318–319
Scenic Ice	38–39	292–293
Scenic Ramada	54–55	298–299
Siphon	–	412–413
Siliconio	192–197	360–361
Skyline	102–105	318–321
Skyline Marble	126–127	326–327
Slide	146–156	332–337
Slide Rectangular	157	337
Soffio	100	318–319
Sortimentsübersicht	290–413	290–413
Spazio	212	368–369
Spiegel	–	378–383
Standwaschtische	198–213	362–371
Terra di Siena	130–143	328–331
Tommy	207	368–369
Tommy Metropole	206	366–367
Tondo Compact	216–217	372–373
Tondo Plus	218–219	372–373
Tower Armaturengriffe	248–257	388–389
Türgriffe/Möbelgriffe	272–275	–
UNIKO	214–229	272–277
Valentino Accessoires	280	394–395
Venice	93	314–317
VETRO FREDDO	144–181	332–351
Valle	143	330–331
Villa / Villa Lux	42–43	294–295
Volé Giotto	45	296–297
Volé Sole	46	294–295
Volta	58	298–299
Xeni	94–95	316–317
Xtreme Marble	128–129	326–327
Xtreme Medium	107	320–321
Xtreme Small	106	320–321
Zubehör	–	408–413



GLASS DESIGN VERTRIEB
DEUTSCHLAND, ÖSTERREICH, SCHWEIZ, BELGIEN

osa GmbH & Co. KG Telefon: ++49 (0) 2371 78888-0
Am Tyrol 21 Telefax: ++49 (0) 2371 78888-19
58636 Iserlohn E-Mail: osa@o-s-a.de
Germany Internet: www.o-s-a.de
 www.myglassdesign.de
Instagram: [myglassdesign](https://www.instagram.com/myglassdesign)
Facebook: [myglassdesign](https://www.facebook.com/myglassdesign)



Made in Italy

Copyright © Glass Design srl.
Tutti i diritti riservati – All rights reserved.
Modell-, Programm- und technische
Änderungen sowie Irrtum vorbehalten.

Bildquellen:
S. 8, 9 Holter St. Johann;
S. 36: Port1, Hamburg; S. 74: Tesch, Sylt;
S. 180: Holter, St. Johann; S. 212, 213: R&F, Würzburg;
S. 134: Bäderbude, Hamburg;
S. 4, 5, 6, 7, 32, 68, 108, 120, 130, 144, 182, 192,
198, 214.; osa GmbH & Co. KG, Iserlohn;
alle anderen Bilder: Glass Design srl., Vinci

Stand: Januar 2023



Folgen Sie uns:



[myglasdesign](https://www.instagram.com/myglasdesign)

www.myglasdesign.de